

BROCAS METAL

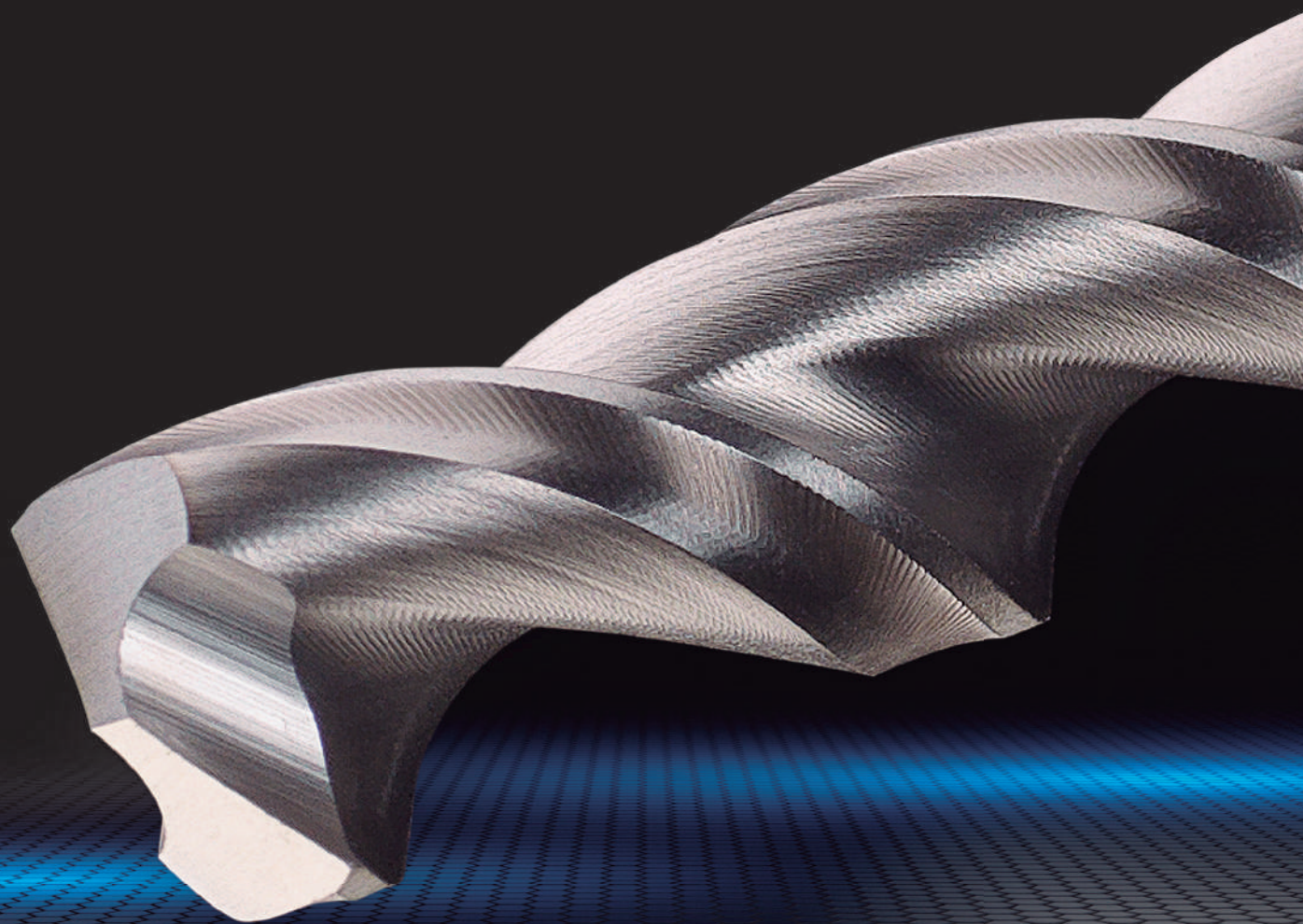

BROCAS HELICOIDALES CON MANGO CILÍNDRICO DIN 338



- 10 U.** Ø 0,20 - Ø 10,50 mm
- 6 U.** Ø 10,60 - Ø 14 mm
- 1 U.** Ø 14,10 - Ø 20 mm
- 1 U.** BC9-BC99
BC7-BC98-BC42



BC01 BC51 BC05 BC95 BC55 BC57 BC50 BC7 BC98 BC42

		BC01	BC51	BC05	BC95	BC55	BC57	BC50	BC7	BC98	BC42
MATERIAL		HSS	HSSCo 5%	HSSCo 5%	HSSCo 5%	HSSCo 5%	HSSCo 5%	HSSCo 5%	PMD	PMD	MD
AFILADO											
ÁNGULO PUNTA		118°	135°	135°	130°	135°	135°	118°	118°	135°	135°
HÉLICE											
ACABADO		TiN	TiAlN	TiAlSiN	DORADO OX	BRILLANTE	TiAlN	TiAlN	BRILLANTE	BRILLANTE	BRILLANTE
APLICACIÓN		PRODUCCIÓN	ALTA PRODUCCIÓN	ALTA PRODUCCIÓN	INOX	INOX	INOX	INOX Plus	FUNDICIÓN	70 HRc	ALTA PRODUCCIÓN
Ø mm	L1 x L2	€	€	€	€	€	€	€	€	€	€
0,20	19 x 2,50										
0,25	19 x 3										
0,30	19 x 3										
0,35	19 x 4										
0,40	20 x 5										
0,45	20 x 5										
0,50	22 x 6										13,93
0,55	24 x 7										
0,60	24 x 7										
0,65	26 x 8										
0,70	28 x 9										
0,75	28 x 9										
0,80	30 x 10										
0,85	30 x 10										
0,90	32 x 11										
0,95	32 x 11										
1,00	34 x 12	2,65	3,01	3,91	2,76	3,65	5,20				8,77
1,05	34 x 12										
1,10	36 x 14										
1,15	36 x 14										
1,19	3/64"										
1,20	38 x 16					4,82	4,99				
1,25	38 x 16										
1,30	38 x 16										
1,35	40 x 18										
1,40	40 x 18										
1,45	40 x 18										
1,50	40 x 18	2,70	3,04	3,62	2,63	3,55	5,19				9,77
1,55	43 x 20										

Brocas Metal
Rosa

Ø 0,20-1,55mm

BROCAS HELICOIDALES CON MANGO CILÍNDRICO DIN 338

Brocas Metal

Gris
Rosa
**DIN
338**

		BC2	BC82	BC02	BC9	BC5	BC99	BC58	BC16	BC66	BC15	BC18
MATERIAL		HSS	HSS	HSS-G	HSS	HSSCo 5%	HSSCo 5%	HSSCo 8%	HSS	HSS	HSS	HSS
AFILADO												
ÁNGULO PUNTA		118°	118°	118°	118°	135°	135°	135°	135°	118°	118°	118°
HÉLICE												
ACABADO		OX	BRILLANTE	DORADO OX	OX	DORADO	DORADO	DORADO	BRILLANTE	BRILLANTE	OX	TiN
APLICACIÓN												
Ø mm	L1 x L2	€	€	€	€	€	€	€	€	€	€	€
1,59	1/16"	1,39				2,50						
1,60	43 x 20	1,46	1,46			2,62						2,09
1,65	43 x 20	1,46	1,46									
1,70	43 x 20	1,46	1,46			2,62						2,08
1,75	46 x 22	1,31	1,31			2,55	3,72	2,42	3,92			2,00
1,80	46 x 22	1,31	1,31			2,62						1,96
1,85	46 x 22	1,31	1,31									
1,90	46 x 22	1,31	1,31			2,62						1,96
1,95	48 x 24	1,31										
1,98	5/64"	1,24				2,45						
2,00	49 x 24	1,12	1,12	1,23		2,15	3,07	2,11	2,46	3,31	1,85	
2,05	49 x 24	1,19	1,19									
2,10	49 x 24	1,19	1,19			2,59						1,83
2,15	53 x 27	1,19										
2,20	53 x 27	1,19	1,19			2,59						1,82
2,25	53 x 27	1,09	1,09	1,22		2,46	3,72	2,39	2,68			1,77
2,30	53 x 27	1,37	1,37			2,59						1,94
2,35	53 x 27	1,38	1,38									
2,38	3/32"	1,30				2,45						
2,40	57 x 30	1,37	1,37			2,59						1,94
2,45	57 x 30	1,37										
2,50	57 x 30	1,16	1,16	1,29		2,02	3,07	1,97	2,32	3,31	1,83	
2,55	57 x 30	1,40	1,40									
2,60	57 x 30	1,40	1,40			2,49						1,95
2,65	57 x 30	1,40										
2,70	61 x 33	1,40	1,40	1,56		2,49						1,95
2,75	61 x 33	1,22	1,22	1,33		2,46	3,72	2,39	3,14			1,91
2,78	7/64"	1,33				2,38						
2,80	61 x 33	1,40	1,40	1,56		2,50						1,95

BROCAS HELICOIDALES CON MANGO CILÍNDRICO DIN 338



- 10 U.** Ø 0,20 - Ø 10,50 mm
- 6 U.** Ø 10,60 - Ø 14 mm
- 1 U.** Ø 14,10 - Ø 20 mm
- 1 U.** BC9-BC99
BC7-BC98-BC42



		BC01	BC51	BC05	BC95	BC55	BC57	BC50	BC7	BC98	BC42
MATERIAL		HSS	HSSCo 5%	HSSCo 5%	HSSCo 5%	HSSCo 5%	HSSCo 5%	HSSCo 5%	PMD	PMD	MD
AFILADO											
ÁNGULO PUNTA		118°	135°	135°	130°	135°	135°	118°	118°	135°	135°
HÉLICE											
ACABADO		TiN	TiAlN	TiAlSiN	DORADO OX	BRILLANTE	TiAlN	TiAlN	BRILLANTE	BRILLANTE	BRILLANTE
APLICACIÓN		PRODUCCIÓN	ALTA PRODUCCIÓN	ALTA PRODUCCIÓN	INOX	INOX	INOX	INOX Plus	FUNDICIÓN	70 HRc	ALTA PRODUCCIÓN
Ø mm	L1 x L2	€	€	€	€	€	€	€	€	€	€
1,59	1/16"										
1,60	43 x 20					4,02					
1,65	43 x 20										
1,70	43 x 20					3,41					
1,75	46 x 22										
1,80	46 x 22					3,58	5,11				
1,85	46 x 22										
1,90	46 x 22					3,93					
1,95	48 x 24										
1,98	5/64"										
2,00	49 x 24	1,88	3,17	3,71	2,63	3,52	5,21	5,24	17,60		12,11
2,05	49 x 24										
2,10	49 x 24					3,68			18,93		16,99
2,15	53 x 27										
2,20	53 x 27					3,72	5,52		18,93		18,26
2,25	53 x 27								18,93		
2,30	53 x 27					3,64			18,93		18,26
2,35	53 x 27										
2,38	3/32"										
2,40	57 x 30					3,73			18,93		18,59
2,45	57 x 30										
2,50	57 x 30	2,02	2,93	3,78	2,47	3,30	4,84	4,96	17,60		14,67
2,55	57 x 30										
2,60	57 x 30					4,00			18,93		22,93
2,65	57 x 30										
2,70	61 x 33					3,81			18,03		22,93
2,75	61 x 33		3,10						18,93		
2,78	7/64"										
2,80	61 x 33					4,13	7,90		18,93		22,93

Brocas Metal
Rosa

Ø 1,59-2,80mm

BROCAS HELICOIDALES CON MANGO CILÍNDRICO DIN 338

Brocas Metal

Gris
Rosa
**DIN
338**

		BC2	BC82	BC02	BC9	BC5	BC99	BC58	BC16	BC66	BC15	BC18
MATERIAL		HSS	HSS	HSS-G	HSS	HSSCo 5%	HSSCo 5%	HSSCo 8%	HSS	HSS	HSS	HSS
AFILADO												
ÁNGULO PUNTA		118°	118°	118°	118°	135°	135°	135°	135°	118°	118°	118°
HÉLICE		30° "N"	30° "N"	30° "N"	30° "N"	30° "N"	30° "N"	30° "N"	40° "W"	15° "H"	30° "N"	30° "N"
ACABADO		OX	BRILLANTE	DORADO OX	OX	DORADO	DORADO	DORADO	BRILLANTE	BRILLANTE	OX	TiN
APLICACIÓN		 70 Kg/mm ²	 70 Kg/mm ²		 12,70	 120 Kg/mm ²	 12,70	 120 Kg/mm ²				
Ø mm	L1 x L2	€	€	€	€	€	€	€	€	€	€	€
2,85	61 x 33	1,41										
2,90	61 x 33	1,40	1,40			2,49						1,95
2,95	61 x 33	1,40										
3,00	61 x 33	1,05	1,05	1,16		1,97		2,97	1,94	2,57	2,88	1,73
3,05	65 x 36	1,36										
3,10	65 x 36	1,22	1,22	1,32		2,39		3,98				2,18
3,15	65 x 36	1,36										
3,17	1/8"	1,17				2,28						
3,20	65 x 36	1,22	1,22	1,32		2,39		3,98	2,39			2,18
3,25	65 x 36	1,22	1,22	1,32		2,39		3,65	2,39	3,14		2,18
3,30	65 x 36	1,22	1,22	1,32		2,39		3,98	2,39			2,18
3,35	65 x 36	1,56										
3,40	70 x 39	1,56	1,56	1,73		2,50						2,35
3,45	70 x 39	1,58										
3,50	70 x 39	1,19	1,19	1,32		2,38		3,59	2,35	2,76	3,42	2,16
3,55	70 x 39	1,63										
3,57	9/64"	1,53				2,86						
3,60	70 x 39	1,63	1,63	1,82		3,00						2,36
3,65	70 x 39	1,63										
3,70	70 x 39	1,63	1,63	1,82		3,00						2,37
3,75	70 x 39	1,37	1,37	1,56		2,83		4,34	2,79	4,10		2,29
3,80	75 x 43	1,67	1,67	1,91		3,00						2,40
3,85	75 x 43	1,67										
3,90	75 x 43	1,67	1,67	1,91		3,00						2,39
3,95	75 x 43	1,67										
3,97	5/32"	1,59				2,86						
4,00	75 x 43	1,32	1,32	1,50		2,54		3,89	2,52	2,99	3,74	2,26
4,05	75 x 43	1,67										
4,10	75 x 43	1,50	1,50	1,67		2,83		4,78	2,75			2,34

BROCAS HELICOIDALES CON MANGO CILÍNDRICO DIN 338



- 10 U.** Ø 0,20 - Ø 10,50 mm
- 6 U.** Ø 10,60 - Ø 14 mm
- 1 U.** Ø 14,10 - Ø 20 mm
- 1 U.** BC9-BC99
BC7-BC98-BC42



BC01 BC51 BC05 BC95 BC55 BC57 BC50 BC7 BC98 BC42

		BC01	BC51	BC05	BC95	BC55	BC57	BC50	BC7	BC98	BC42
MATERIAL		HSS	HSSCo 5%	HSSCo 5%	HSSCo 5%	HSSCo 5%	HSSCo 5%	HSSCo 5%	PMD	PMD	MD
AFILADO											
ÁNGULO PUNTA		118°	135°	135°	130°	135°	135°	118°	118°	135°	135°
HÉLICE											
ACABADO		TiN	TiAlN	TiAlSiN	DORADO OX	BRILLANTE	TiAlN	TiAlN	BRILLANTE	BRILLANTE	BRILLANTE
APLICACIÓN		PRODUCCIÓN	ALTA PRODUCCIÓN	ALTA PRODUCCIÓN	INOX	INOX	INOX	INOX Plus	FUNDICIÓN	70 HRc	ALTA PRODUCCIÓN
Ø mm	L1 x L2	€	€	€	€	€	€	€	€	€	€
2,85	61 x 33										
2,90	61 x 33					4,16			18,93		22,93
2,95	61 x 33										
3,00	61 x 33	1,88	2,89	3,73	2,42	3,19	4,79	4,99	17,51	13,14	17,60
3,05	65 x 36										
3,10	65 x 36					3,85	5,89		17,91		23,15
3,15	65 x 36										
3,17	1/8"										
3,20	65 x 36				2,95	3,85	5,93		17,58		23,15
3,25	65 x 36								18,09		
3,30	65 x 36	2,35	3,65	4,40	2,96	3,85	5,90	6,07	17,76	14,86	20,36
3,35	65 x 36										
3,40	70 x 39					4,49			18,09		25,39
3,45	70 x 39										
3,50	70 x 39	2,37	3,63	4,65	2,91	3,89	5,86	5,93	17,16	13,71	20,08
3,55	70 x 39										
3,57	9/64"										
3,60	70 x 39					4,49			17,91	14,86	26,61
3,65	70 x 39										
3,70	70 x 39					4,49			18,43		26,61
3,75	70 x 39								18,43		
3,80	75 x 43					5,12	8,51		18,43		27,90
3,85	75 x 43										
3,90	75 x 43					4,90			18,43		27,90
3,95	75 x 43										
3,97	5/32"										
4,00	75 x 43	2,51	3,75	4,75	3,17	4,18	6,17	6,37	17,50	13,35	22,58
4,05	75 x 43										
4,10	75 x 43					4,62	6,65		17,69		29,01

Brocas Metal

Rosa

Ø 2,85-4,10mm

BROCAS HELICOIDALES CON MANGO CILÍNDRICO DIN 338
**DIN
338**

		BC2	BC82	BC02	BC9	BC5	BC99	BC58	BC16	BC66	BC15	BC18
MATERIAL		HSS	HSS	HSS-G	HSS	HSSCo 5%	HSSCo 5%	HSSCo 8%	HSS	HSS	HSS	HSS
AFILADO												
ÁNGULO PUNTA		118°	118°	118°	118°	135°	135°	135°	135°	118°	118°	118°
HÉLICE												
ACABADO		OX	BRILLANTE	DORADO OX	OX	DORADO	DORADO	DORADO	BRILLANTE	BRILLANTE	OX	TiN
APLICACIÓN												
Ø mm	L1 x L2	€	€	€	€	€	€	€	€	€	€	€
4,15	75 x 43	1,67										
4,20	75 x 43	1,50	1,50			2,83		4,78	2,75			2,34
4,25	75 x 43	1,50	1,50	1,67		2,83		4,34	3,20	4,43		2,34
4,30	80 x 47	1,98	1,98	2,26		3,00						2,60
4,35	80 x 47	1,96										
4,37	11/64"	1,87				2,86						
4,40	80 x 47	1,98	1,98	2,26		3,00						2,60
4,45	80 x 47	1,98										
4,50	80 x 47	1,56	1,56	1,70		2,92		4,34	2,82	3,65	3,88	2,37
4,55	80 x 47	2,01										
4,60	80 x 47	2,01	2,01			3,35						2,61
4,65	80 x 47	2,01										
4,70	80 x 47	2,01	2,01	2,26		3,35						2,61
4,75	80 x 47	1,79	1,79	2,02		3,18		4,80	3,60	5,36		2,52
4,76	3/16"	1,70				2,97						
4,80	86 x 52	2,26	2,26	2,46		3,36		5,28				2,77
4,85	86 x 52	2,18										
4,90	86 x 52	2,18	2,18	2,42		3,36						2,74
4,95	86 x 52	2,19										
5,00	86 x 52	1,66	1,66	1,86		3,05		4,65	3,02	3,96	4,22	2,43
5,05	86 x 52	2,27	2,27									
5,10	86 x 52	2,26	2,26	2,49		3,65		5,69	3,49		5,85	2,76
5,15	86 x 52	2,27										
5,16	13/64"	2,16				3,14						
5,20	86 x 52	2,26	2,26	2,49		3,65		5,69				2,77
5,25	86 x 52	2,11	2,11	2,39		3,60		5,46	4,31	6,01		2,75
5,30	86 x 52	2,80	2,80	3,10		3,65						3,13
5,35	93 x 57	2,79										
5,40	93 x 57	2,80	2,80			3,65						3,13

BROCAS HELICOIDALES CON MANGO CILÍNDRICO DIN 338



- 10 U.** Ø 0,20 - Ø 10,50 mm
- 6 U.** Ø 10,60 - Ø 14 mm
- 1 U.** Ø 14,10 - Ø 20 mm
- 1 U.** BC9-BC99
BC7-BC98-BC42



BC01 BC51 BC05 BC95 BC55 BC57 BC50 BC7 BC98 BC42

		BC01	BC51	BC05	BC95	BC55	BC57	BC50	BC7	BC98	BC42
MATERIAL		HSS	HSSCo 5%	HSSCo 5%	HSSCo 5%	HSSCo 5%	HSSCo 5%	HSSCo 5%	PMD	PMD	MD
AFILADO											
ÁNGULO PUNTA		118°	135°	135°	130°	135°	135°	118°	118°	135°	135°
HÉLICE											
ACABADO		TiN	TiAlN	TiAlSiN	DORADO OX	BRILLANTE	TiAlN	TiAlN	BRILLANTE	BRILLANTE	BRILLANTE
APLICACIÓN		PRODUCCIÓN	ALTA PRODUCCIÓN	ALTA PRODUCCIÓN	INOX	INOX	INOX	INOX Plus	FUNDICIÓN	70 HRc	ALTA PRODUCCIÓN
Ø mm	L1 x L2	€	€	€	€	€	€	€	€	€	€
4,15	75 x 43										
4,20	75 x 43	2,58	3,94	4,98	3,53	4,60	6,64	7,49	17,69	15,55	27,63
4,25	75 x 43		3,94	4,98					19,28		
4,30	80 x 47					4,91	7,10		19,28	15,55	34,52
4,35	80 x 47										
4,37	11/64"										
4,40	80 x 47					4,91			19,28	15,55	35,22
4,45	80 x 47										
4,50	80 x 47	2,58	3,97	4,88	3,53	4,77	6,78	7,01	17,37	12,83	27,60
4,55	80 x 47										
4,60	80 x 47					5,92			18,57		34,35
4,65	80 x 47										
4,70	80 x 47					5,50			18,05		34,35
4,75	80 x 47								19,28		
4,76	3/16"										
4,80	86 x 52					5,50	7,52		18,57		35,22
4,85	86 x 52										
4,90	86 x 52					6,07			19,28		35,22
4,95	86 x 52										
5,00	86 x 52	2,72	4,07	5,06	3,77	4,97	6,96	7,39	17,82	12,57	30,35
5,05	86 x 52										
5,10	86 x 52					5,93	7,90		19,05	15,38	39,94
5,15	86 x 52										
5,16	13/64"										
5,20	86 x 52					5,90	7,96		18,96		39,94
5,25	86 x 52								20,26		
5,30	86 x 52					5,93			20,26		39,94
5,35	93 x 57										
5,40	93 x 57					7,68			20,26		45,21

Brocas Metal

Rosa

Ø 4,15-5,40mm

BROCAS HELICOIDALES CON MANGO CILÍNDRICO DIN 338

Brocas Metal

Gris
Rosa
**DIN
338**

		BC2	BC82	BC02	BC9	BC5	BC99	BC58	BC16	BC66	BC15	BC18
MATERIAL		HSS	HSS	HSS-G	HSS	HSSCo 5%	HSSCo 5%	HSSCo 8%	HSS	HSS	HSS	HSS
AFILADO												
ÁNGULO PUNTA		118°	118°	118°	118°	135°	135°	135°	135°	118°	118°	118°
HÉLICE												
ACABADO		OX	BRILLANTE	DORADO OX	OX	DORADO	DORADO	DORADO	BRILLANTE	BRILLANTE	OX	TiN
APLICACIÓN												
Ø mm	L1 x L2	70 Kg/mm ²	70 Kg/mm ²	Plus	12,70	120 Kg/mm ²	12,70	120 Kg/mm ²	Al	LATÓN		PRODUCCIÓN
		€	€	€	€	€	€	€	€	€	€	€
5,45	93 x 57	2,80										
5,50	93 x 57	2,19	2,19	2,46		3,87		5,87	3,83	4,84	5,57	2,79
5,55	93 x 57	2,97										
5,56	7/32"	2,82				4,37						
5,60	93 x 57	2,98	2,98	3,30		4,59		7,25				3,26
5,65	93 x 57	2,97										
5,70	93 x 57	2,98	2,98	3,30		4,59		7,25				3,26
5,75	93 x 57	2,87	2,87	3,21		4,36		6,56	5,28	7,35		3,23
5,80	93 x 57	2,79	2,79	3,15		4,59		7,25				3,13
5,85	93 x 57	2,80										
5,90	93 x 57	2,79	2,79	3,15		4,59						3,13
5,95	15/64"	2,65				4,78						
6,00	93 x 57	2,29	2,29	2,54		4,12		6,25	4,05	5,20	5,75	2,85
6,05	101 x 63	3,21										
6,10	101 x 63	3,21	3,21	3,63		5,10						5,64
6,15	101 x 63	3,21										
6,20	101 x 63	3,21	3,21	3,63		5,10						5,64
6,25	101 x 63	3,03	3,03	3,39		4,81		7,31	5,28	7,35		5,64
6,30	101 x 63	3,38	3,38			5,10						5,71
6,35	1/4"	2,43				4,85						
6,40	101 x 63	3,49	3,49			5,11						5,80
6,45	101 x 63	3,40										
6,50	101 x 63	2,63	2,63	2,97		4,94		7,29	4,72	5,79	6,69	5,37
6,55	101 x 63	4,24										
6,60	101 x 63	4,21	4,21			6,12						6,25
6,65	101 x 63	4,24										
6,70	101 x 63	4,23	4,23	4,71		6,12		9,35				6,25
6,75	109 x 69	3,19	3,19	3,59		5,75		8,54	6,36	8,87		5,74
6,80	109 x 69	3,19	3,19	3,59		5,75		9,35	5,54			5,75

BROCAS HELICOIDALES CON MANGO CILÍNDRICO DIN 338



- 10 U.** Ø 0,20 - Ø 10,50 mm
- 6 U.** Ø 10,60 - Ø 14 mm
- 1 U.** Ø 14,10 - Ø 20 mm
- 1 U.** BC9-BC99
BC7-BC98-BC42



		BC01	BC51	BC05	BC95	BC55	BC57	BC50	BC7	BC98	BC42
MATERIAL		HSS	HSSCo 5%	HSSCo 5%	HSSCo 5%	HSSCo 5%	HSSCo 5%	HSSCo 5%	PMD	PMD	MD
AFILADO											
ÁNGULO PUNTA		118°	135°	135°	130°	135°	135°	118°	118°	135°	135°
HÉLICE											
ACABADO		TiN	TiAlN	TiAlSiN	DORADO OX	BRILLANTE	TiAlN	TiAlN	BRILLANTE	BRILLANTE	BRILLANTE
APLICACIÓN		PRODUCCIÓN	ALTA PRODUCCIÓN	ALTA PRODUCCIÓN	INOX	INOX	INOX	INOX Plus	FUNDICIÓN	70 HRc	ALTA PRODUCCIÓN
Ø mm	L1 x L2	€	€	€	€	€	€	€	€	€	€
5,45	93 x 57										
5,50	93 x 57	3,12	4,60	5,55	4,78	6,30	8,33	9,03	18,66	13,40	35,08
5,55	93 x 57										
5,56	7/32"										
5,60	93 x 57					7,52			19,83		47,49
5,65	93 x 57										
5,70	93 x 57					8,65			19,82		47,49
5,75	93 x 57					7,11			21,19		
5,80	93 x 57					7,52	9,53		19,82		47,49
5,85	93 x 57										
5,90	93 x 57					7,52			21,19		47,49
5,95	15/64"										
6,00	93 x 57	3,13	4,76	5,55	5,08	6,75	8,76	10,02	19,33	14,28	40,55
6,05	101 x 63										
6,10	101 x 63				5,35	9,38			22,87		58,82
6,15	101 x 63										
6,20	101 x 63					8,34	13,74		22,87		58,82
6,25	101 x 63								22,87		
6,30	101 x 63					9,38			22,87		58,82
6,35	1/4"										
6,40	101 x 63					9,38			22,87		58,82
6,45	101 x 63										
6,50	101 x 63	5,95	8,86	11,37	5,93	8,09	13,50	13,63	21,59	14,55	50,36
6,55	101 x 63										
6,60	101 x 63					10,62			23,58		73,13
6,65	101 x 63										
6,70	101 x 63					10,62			23,58		73,13
6,75	109 x 69		9,30	11,71					23,58		
6,80	109 x 69	6,15	9,30	11,71	6,91	9,42	14,85		23,58	17,42	59,04

Brocas Metal

Rosa

Ø 5,45-6,80mm

BROCAS HELICOIDALES CON MANGO CILÍNDRICO DIN 338

Brocas Metal

Gris
Rosa
**DIN
338**

		BC2	BC82	BC02	BC9	BC5	BC99	BC58	BC16	BC66	BC15	BC18
MATERIAL		HSS	HSS	HSS-G	HSS	HSSCo 5%	HSSCo 5%	HSSCo 8%	HSS	HSS	HSS	HSS
AFILADO												
ÁNGULO PUNTA		118°	118°	118°	118°	135°	135°	135°	135°	118°	118°	118°
HÉLICE												
ACABADO		OX	BRILLANTE	DORADO OX	OX	DORADO	DORADO	DORADO	BRILLANTE	BRILLANTE	OX	TiN
APLICACIÓN												
Ø mm	L1 x L2	€	€	€	€	€	€	€	€	€	€	€
6,85	109 x 69	4,69										
6,90	109 x 69	4,70	4,70			6,12						6,51
6,95	109 x 69	4,70										
7,00	109 x 69	3,19	3,19	3,59		5,40		7,64	5,16	6,15	8,17	5,75
7,05	109 x 69	4,95										
7,10	109 x 69	4,94	4,94			7,81						6,74
7,14	9/32"	4,73				7,37						
7,15	109 x 69	4,96										
7,20	109 x 69	4,94	4,94			7,81					8,58	6,74
7,25	109 x 69	4,07	4,07	4,53		7,33		10,38	8,41	11,63		6,30
7,30	109 x 69	4,95	4,95			7,82						6,74
7,35	109 x 69	4,94										
7,40	109 x 69	4,95	4,95	5,54		7,82						6,74
7,45	109 x 69	5,07										
7,50	109 x 69	3,38	3,38	3,78		5,76		8,15	5,52	7,20	8,58	5,88
7,54	19/64"	5,52				8,93						
7,55	117 x 75	5,86										
7,60	117 x 75	5,83	5,83			9,42						7,40
7,65	117 x 75	5,86										
7,70	117 x 75	5,83	5,83			9,39						7,40
7,75	117 x 75	4,49	4,49	5,03		8,87		12,58	10,70	15,51		6,67
7,80	117 x 75	5,91	5,91	6,65		9,39						7,42
7,85	117 x 75	5,92										
7,90	117 x 75	5,91	5,91	6,65		9,44						7,42
7,94	5/16"	5,05				8,90						
7,95	117 x 75	5,91										
8,00	117 x 75	3,87	3,87	4,34		6,76		9,89	6,43	7,64	9,82	6,15
8,05	117 x 75	6,04										
8,10	117 x 75	6,04	6,04			9,00						8,13

BROCAS HELICOIDALES CON MANGO CILÍNDRICO DIN 338



- 10 U.** Ø 0,20 - Ø 10,50 mm
- 6 U.** Ø 10,60 - Ø 14 mm
- 1 U.** Ø 14,10 - Ø 20 mm
- 1 U.** BC9-BC99
BC7-BC98-BC42



		BC01	BC51	BC05	BC95	BC55	BC57	BC50	BC7	BC98	BC42
MATERIAL		HSS	HSSCo 5%	HSSCo 5%	HSSCo 5%	HSSCo 5%	HSSCo 5%	HSSCo 5%	PMD	PMD	MD
AFILADO											
ÁNGULO PUNTA		118°	135°	135°	130°	135°	135°	118°	118°	135°	135°
HÉLICE											
ACABADO		TiN	TiAlN	TiAlSiN	DORADO OX	BRILLANTE	TiAlN	TiAlN	BRILLANTE	BRILLANTE	BRILLANTE
APLICACIÓN		PRODUCCIÓN	ALTA PRODUCCIÓN	ALTA PRODUCCIÓN	INOX	INOX	INOX	INOX Plus	FUNDICIÓN	70 HRc	ALTA PRODUCCIÓN
Ø mm	L1 x L2	€	€	€	€	€	€	€	€	€	€
6,85	109 x 69										
6,90	109 x 69					10,72			23,58	17,42	73,13
6,95	109 x 69										
7,00	109 x 69	6,33	9,36	11,94	6,49	8,78	14,43	14,69	23,52	16,29	58,64
7,05	109 x 69										
7,10	109 x 69					12,98			24,73	18,76	83,64
7,14	9/32"										
7,15	109 x 69										
7,20	109 x 69					12,43	17,93		24,73		83,64
7,25	109 x 69								24,73		
7,30	109 x 69					13,23			24,73		83,64
7,35	109 x 69										
7,40	109 x 69					13,23			24,73		83,64
7,45	109 x 69										
7,50	109 x 69	6,46	9,61	12,43	6,89	9,38	15,04	16,14	24,29	17,12	62,63
7,54	19/64"										
7,55	117 x 75										
7,60	117 x 75					13,61			26,56		83,64
7,65	117 x 75										
7,70	117 x 75					15,14			26,56		83,64
7,75	117 x 75								26,56		
7,80	117 x 75					15,14	21,33		26,56		83,64
7,85	117 x 75										
7,90	117 x 75					15,14			26,56		83,64
7,94	5/16"										
7,95	117 x 75										
8,00	117 x 75	6,80	10,19	12,52	8,07	11,00	16,60	17,05	24,74	19,12	71,53
8,05	117 x 75										
8,10	117 x 75					15,95			28,37		97,30

Brocas Metal

Rosa

Ø 6,85-8,10mm

BROCAS HELICOIDALES CON MANGO CILÍNDRICO DIN 338
**DIN
338**

		BC2	BC82	BC02	BC9	BC5	BC99	BC58	BC16	BC66	BC15	BC18
MATERIAL		HSS	HSS	HSS-G	HSS	HSSCo 5%	HSSCo 5%	HSSCo 8%	HSS	HSS	HSS	HSS
AFILADO												
ÁNGULO PUNTA		118°	118°	118°	118°	135°	135°	135°	135°	118°	118°	118°
HÉLICE												
ACABADO		OX	BRILLANTE	DORADO OX	OX	DORADO	DORADO	DORADO	BRILLANTE	BRILLANTE	OX	TiN
APLICACIÓN												
Ø mm	L1 x L2	€	€	€	€	€	€	€	€	€	€	€
8,15	117 x 75	6,03										
8,20	117 x 75	6,02	6,02	6,77		9,00						8,13
8,25	117 x 75	4,53	4,53	5,07		8,47		12,44	10,36	14,47		7,32
8,30	117 x 75	6,26	6,26	7,07		9,00						8,32
8,33	21/64"	5,96				8,53						
8,35	117 x 75	6,30										
8,40	117 x 75	6,32	6,32			9,00						8,32
8,45	117 x 75	6,32										
8,50	117 x 75	4,17	4,17	4,70		7,02		10,29	6,75	8,87	10,62	7,00
8,55	125 x 81	7,90										
8,60	125 x 81	7,89	7,89	8,89		11,46						9,33
8,65	125 x 81	7,89										
8,70	125 x 81	7,88	7,88			11,46		17,45				9,33
8,73	11/32"	5,73				10,16						
8,75	125 x 81	6,08	6,08	6,83		10,77		15,87	13,03	16,73		8,31
8,80	125 x 81	7,92	7,92	8,96		11,46						9,35
8,85	125 x 81	7,93										
8,90	125 x 81	7,92	7,92			11,46						9,35
8,95	125 x 81	7,93										
9,00	125 x 81	5,11	5,11	5,71		8,95		13,13	8,55	9,42	12,93	7,52
9,05	125 x 81	7,98										
9,10	125 x 81	7,95	7,95			12,72						9,39
9,13	23/64"	7,57				12,03						
9,15	125 x 81	7,98										
9,20	125 x 81	7,98	7,98			12,69						9,39
9,25	125 x 81	6,13	6,13	6,89		11,88		17,55	14,45	22,75		8,30
9,30	125 x 81	7,43	7,43			12,71						9,07
9,35	125 x 81	9,86										
9,40	125 x 81	7,43	7,43			12,67						9,07
9,45	125 x 81	7,44										

BROCAS HELICOIDALES CON MANGO CILÍNDRICO DIN 338



- 10 U.** Ø 0,20 - Ø 10,50 mm
- 6 U.** Ø 10,60 - Ø 14 mm
- 1 U.** Ø 14,10 - Ø 20 mm
- 1 U.** BC9-BC99
BC7-BC98-BC42



BC01 BC51 BC05 BC95 BC55 BC57 BC50 BC7 BC98 BC42

		BC01	BC51	BC05	BC95	BC55	BC57	BC50	BC7	BC98	BC42
MATERIAL		HSS	HSSCo 5%	HSSCo 5%	HSSCo 5%	HSSCo 5%	HSSCo 5%	HSSCo 5%	PMD	PMD	MD
AFILADO											
ÁNGULO PUNTA		118°	135°	135°	130°	135°	135°	118°	118°	135°	135°
HÉLICE											
ACABADO		TiN	TiAlN	TiAlSiN	DORADO OX	BRILLANTE	TiAlN	TiAlN	BRILLANTE	BRILLANTE	BRILLANTE
APLICACIÓN		PRODUCCIÓN	ALTA PRODUCCIÓN	ALTA PRODUCCIÓN	INOX	INOX	INOX	INOX Plus	FUNDICIÓN	70 HRc	ALTA PRODUCCIÓN
Ø mm	L1 x L2	€	€	€	€	€	€	€	€	€	€
8,15	117 x 75										
8,20	117 x 75					14,87	21,46		28,37		97,30
8,25	117 x 75								28,37		
8,30	117 x 75					15,80			28,37		97,30
8,33	21/64"										
8,35	117 x 75										
8,40	117 x 75					15,80			28,37		97,30
8,45	117 x 75										
8,50	117 x 75	7,72	11,40	14,49	8,42	11,39	18,04	20,90	27,13	19,12	84,59
8,55	125 x 81										
8,60	125 x 81					16,11			30,47	23,13	112,79
8,65	125 x 81										
8,70	125 x 81					18,73			30,47		112,79
8,73	11/32"										
8,75	125 x 81								30,47		
8,80	125 x 81					18,32	24,84		30,47		112,79
8,85	125 x 81										
8,90	125 x 81					18,73			30,47		112,79
8,95	125 x 81										
9,00	125 x 81	8,35	12,63	15,27	10,73	14,54	21,22	22,19	27,07	20,74	93,52
9,05	125 x 81										
9,10	125 x 81					23,06			32,94		123,91
9,13	23/64"										
9,15	125 x 81										
9,20	125 x 81					23,06	26,76		32,94		123,91
9,25	125 x 81								32,94		
9,30	125 x 81					23,06			32,94		123,91
9,35	125 x 81										
9,40	125 x 81					23,06			32,94		123,91
9,45	125 x 81										

Brocas Metal

Rosa

Ø 8,15-9,45mm

BROCAS HELICOIDALES CON MANGO CILÍNDRICO DIN 338

Brocas Metal

Gris
Rosa
**DIN
338**

		BC2	BC82	BC02	BC9	BC5	BC99	BC58	BC16	BC66	BC15	BC18
MATERIAL		HSS	HSS	HSS-G	HSS	HSSCo 5%	HSSCo 5%	HSSCo 8%	HSS	HSS	HSS	HSS
AFILADO												
ÁNGULO PUNTA		118°	118°	118°	118°	135°	135°	135°	135°	118°	118°	118°
HÉLICE												
ACABADO		OX	BRILLANTE	DORADO OX	OX	DORADO	DORADO	DORADO	BRILLANTE	BRILLANTE	OX	TiN
APLICACIÓN												
Ø mm	L1 x L2	€	€	€	€	€	€	€	€	€	€	€
9,50	125 x 81	5,55	5,55	6,21		9,25		13,59	8,88	11,03	14,06	7,83
9,52	3/8"	5,21				8,81						
9,55	133 x 87	9,58										
9,60	133 x 87	9,46	9,46			14,90						10,42
9,65	133 x 87	9,58										
9,70	133 x 87	9,46	9,46			14,90						10,34
9,75	133 x 87	6,90	6,90	7,81		14,03		20,69	14,53	24,70		8,87
9,80	133 x 87	9,26	9,26			14,90						10,27
9,85	133 x 87	9,36										
9,90	133 x 87	9,36	9,36	10,53		14,90						10,27
9,92	25/64"	8,91				14,06						
9,95	133 x 87	9,35										
10,00	133 x 87	5,97	5,97	6,68	9,87	10,23		15,01	9,83	11,47	15,15	8,12
10,10	133 x 87	7,98	7,98	8,98		17,14						
10,20	133 x 87	7,44	7,44	8,33		14,44		27,14				14,26
10,25	133 x 87	8,32	8,32	10,31	13,02	17,67		27,14	16,13	28,15		14,47
10,30	133 x 87	9,31	9,31	10,42		17,17						
10,32	13/32"	8,91				16,28						
10,40	133 x 87	9,31	9,31			17,14						
10,50	133 x 87	7,42	7,42	8,32	11,06	14,45	21,48	22,08	13,11	13,78	20,71	13,53
10,60	133 x 87	10,27	10,27			19,92						
10,70	142 x 94	10,27	10,27			19,92						
10,72	27/64"	9,14				19,52						
10,75	142 x 94	9,60	9,60	10,62	14,72	20,70		31,58	18,87	25,70		14,93
10,80	142 x 94	11,38	11,38			19,92						
10,90	142 x 94	11,38	11,38			19,96						
11,00	142 x 94	8,67	8,67	9,72	12,53	15,96	22,94	24,36	14,24	15,33	23,74	14,30
11,10	142 x 94	11,61	11,61			22,73						
11,11	7 / 16"	11,06				21,44						
11,20	142 x 94	11,61	11,61			22,73						

BROCAS HELICOIDALES CON MANGO CILÍNDRICO DIN 338



- 10 U.** Ø 0,20 - Ø 10,50 mm
- 6 U.** Ø 10,60 - Ø 14 mm
- 1 U.** Ø 14,10 - Ø 20 mm
- 1 U.** BC9-BC99
BC7-BC98-BC42



BC01 BC51 BC05 BC95 BC55 BC57 BC50 BC7 BC98 BC42

		BC01	BC51	BC05	BC95	BC55	BC57	BC50	BC7	BC98	BC42
MATERIAL		HSS	HSSCo 5%	HSSCo 5%	HSSCo 5%	HSSCo 5%	HSSCo 5%	HSSCo 5%	PMD	PMD	MD
AFILADO											
ÁNGULO PUNTA		118°	135°	135°	130°	135°	135°	118°	118°	135°	135°
HÉLICE											
ACABADO		TiN	TiAlN	TiAlSiN	DORADO OX	BRILLANTE	TiAlN	TiAlN	BRILLANTE	BRILLANTE	BRILLANTE
APLICACIÓN		PRODUCCIÓN	ALTA PRODUCCIÓN	ALTA PRODUCCIÓN	INOX	INOX	INOX	INOX Plus	FUNDICIÓN	70 HRc	ALTA PRODUCCIÓN
Ø mm	L1 x L2	€	€	€	€	€	€	€	€	€	€
9,50	125 x 81	8,78	12,82	15,70	11,11	15,11	21,58	25,15	29,53	22,62	103,97
9,52	3/8"										
9,55	133 x 87										
9,60	133 x 87					23,06			35,33		131,42
9,65	133 x 87										
9,70	133 x 87					23,06			35,33		131,42
9,75	133 x 87								35,33		
9,80	133 x 87					22,94	29,56		35,33		131,42
9,85	133 x 87										
9,90	133 x 87					24,91			35,33		131,42
9,92	25/64"										
9,95	133 x 87										
10,00	133 x 87	8,95	13,44	16,11	12,22	16,65	23,21	27,73	29,59	23,21	112,40
10,10	133 x 87								39,58		
10,20	133 x 87	16,91	23,17	27,86	16,50	24,91	32,12	32,29	38,13	30,04	129,95
10,25	133 x 87								39,58		
10,30	133 x 87								39,58	30,04	
10,32	13/32"										
10,40	133 x 87								39,58		
10,50	133 x 87	16,83	23,15	28,04	16,51	23,60	36,88	37,43	37,84	29,81	124,53
10,60	133 x 87								42,10		
10,70	142 x 94								42,10		
10,72	27/64"										
10,75	142 x 94								42,10		
10,80	142 x 94					33,16			42,10		
10,90	142 x 94								42,10		
11,00	142 x 94	15,59	24,13	28,97	18,22	26,09	39,05	39,42	37,99	29,94	148,30
11,10	142 x 94								45,08		
11,11	7 / 16"										
11,20	142 x 94					40,26			45,08		

Brocas Metal

Rosa

Ø 9,50-11,20mm

BROCAS HELICOIDALES CON MANGO CILÍNDRICO DIN 338

Brocas Metal

Gris
Rosa
**DIN
338**

		BC2	BC82	BC02	BC9	BC5	BC99	BC58	BC16	BC66	BC15	BC18
MATERIAL		HSS	HSS	HSS-G	HSS	HSSCo 5%	HSSCo 5%	HSSCo 8%	HSS	HSS	HSS	HSS
AFILADO												
ÁNGULO PUNTA		118°	118°	118°	118°	135°	135°	135°	135°	118°	118°	118°
HÉLICE												
ACABADO		OX	BRILLANTE	DORADO OX	OX	DORADO	DORADO	DORADO	BRILLANTE	BRILLANTE	OX	TiN
APLICACIÓN												
Ø mm	L1 x L2	€	€	€	€	€	€	€	€	€	€	€
11,25	142 x 94	9,85	9,85	11,42	15,57	23,57		37,04	24,84	33,86		15,06
11,30	142 x 94	11,38	11,38			22,71						
11,40	142 x 94	11,38	11,38			22,73						
11,50	142 x 94	9,26	9,26	10,41	13,22	19,10	24,81	31,15	16,83	18,43	28,07	14,70
11,51	29/64"	8,82				18,10						
11,60	142 x 94	11,38	11,38			23,46						
11,70	142 x 94	11,38	11,38			23,46						
11,75	142 x 94	9,85	9,85	11,76	16,96	24,37		39,86	24,37	33,86		15,06
11,80	142 x 94	12,47	12,47			23,46						
11,90	151 x 101	12,47	12,47			23,46						
11,91	15/32"	11,88				22,24						
12,00	151 x 101	10,30	10,30	11,60	14,47	20,36	26,60	33,37	18,05	19,96	28,22	15,35
12,10	151 x 101	14,52	14,52			27,26						
12,20	151 x 101	14,52	14,52			27,26						
12,25	151 x 101	12,83	12,83	14,42	18,41	28,21		47,58	33,87	46,15		19,23
12,30	151 x 101	13,68	13,68			27,26						
12,40	151 x 101	13,68	13,68			27,26						
12,50	151 x 101	11,34	11,34	12,72	15,70	24,86	32,37	41,86	20,08	22,64	34,39	18,24
12,60	151 x 101	14,19	14,19			28,34						
12,70	1/2"	12,55				26,99						
12,75	151 x 101	12,61	12,61	14,41	18,97	29,44		49,68	37,39	51,25		19,08
12,80	151 x 101	15,82	15,82			28,34						
12,90	151 x 101	15,82	15,82			28,34						
13,00	151 x 101	11,75	11,75	13,09	16,14	25,44	34,16	42,46	20,37	24,35	35,59	18,52
13,10	151 x 101	16,19	16,19									
13,20	151 x 101	16,19	16,19									
13,25	160 x 108	18,48	18,48		23,07	35,22						
13,30	160 x 108	25,08	25,08									
13,40	160 x 108	25,08	25,08									
13,49	17/32"	15,87				26,70						

BROCAS HELICOIDALES CON MANGO CILÍNDRICO DIN 338



- 10 U.** Ø 0,20 - Ø 10,50 mm
- 6 U.** Ø 10,60 - Ø 14 mm
- 1 U.** Ø 14,10 - Ø 20 mm
- 1 U.** BC9-BC99
BC7-BC98-BC42



		BC01	BC51	BC05	BC95	BC55	BC57	BC50	BC7	BC98	BC42
MATERIAL		HSS	HSSCo 5%	HSSCo 5%	HSSCo 5%	HSSCo 5%	HSSCo 5%	HSSCo 5%	PMD	PMD	MD
AFILADO											
ÁNGULO PUNTA		118°	135°	135°	130°	135°	135°	118°	118°	135°	135°
HÉLICE											
ACABADO		TiN	TiAlN	TiAlSiN	DORADO OX	BRILLANTE	TiAlN	TiAlN	BRILLANTE	BRILLANTE	BRILLANTE
APLICACIÓN		PRODUCCIÓN	ALTA PRODUCCIÓN	ALTA PRODUCCIÓN	INOX	INOX	INOX	INOX Plus	FUNDICIÓN	70 HRc	ALTA PRODUCCIÓN
Ø mm	L1 x L2	€	€	€	€	€	€	€	€	€	€
11,25	142 x 94								45,08		
11,30	142 x 94								45,08		
11,40	142 x 94								45,08		
11,50	142 x 94	16,14	25,62	30,16	20,97	31,08	43,93	44,46	43,67	34,40	163,82
11,51	29/64"										
11,60	142 x 94								49,71	37,73	
11,70	142 x 94								49,71		
11,75	142 x 94								49,71		
11,80	142 x 94					41,53			49,71		
11,90	151 x 101								49,71		
11,91	15/32"										
12,00	151 x 101	16,80	26,51	30,86	22,48	33,16	46,18	46,31	43,45	34,24	195,21
12,10	151 x 101								52,34	39,72	
12,20	151 x 101								52,34		
12,25	151 x 101								52,34		
12,30	151 x 101								52,34		
12,40	151 x 101								52,34		
12,50	151 x 101	19,78	32,76	38,14	27,44	40,39	49,93	52,42	52,09		266,70
12,60	151 x 101								55,30		
12,70	1/2"								55,30		
12,75	151 x 101								55,30		
12,80	151 x 101								55,30		
12,90	151 x 101								55,30		
13,00	151 x 101	19,64	33,25	38,55	27,84	41,52	57,68	57,85	52,00		211,07
13,10	151 x 101										
13,20	151 x 101										
13,25	160 x 108										
13,30	160 x 108										
13,40	160 x 108										
13,49	17/32"										

Brocas Metal

Rosa

Ø 11,25-13,49mm

BROCAS HELICOIDALES CON MANGO CILÍNDRICO DIN 338
**DIN
338**

		BC2	BC82	BC02	BC9	BC5	BC99	BC58	BC16	BC66	BC15	BC18
MATERIAL		HSS	HSS	HSS-G	HSS	HSSCo 5%	HSSCo 5%	HSSCo 8%	HSS	HSS	HSS	HSS
AFILADO												
ÁNGULO PUNTA		118°	118°	118°	118°	135°	135°	135°	135°	118°	118°	118°
HÉLICE												
ACABADO		OX	BRILLANTE	DORADO OX	OX	DORADO	DORADO	DORADO	BRILLANTE	BRILLANTE	OX	TiN
APLICACIÓN												
Ø mm	L1 x L2	€	€	€	€	€	€	€	€	€	€	€
13,50	160 x 108	16,66	16,66	18,69	21,51	28,04	36,29	46,79				22,60
13,60	160 x 108	25,08	25,08									
13,70	160 x 108	25,08	25,08									
13,75	160 x 108	18,69	18,69		24,74	35,22						
13,80	160 x 108	23,91	23,91									
13,89	35/64"	22,87				31,52						
13,90	160 x 108	24,01	24,01									
14,00	160 x 108	17,84	17,84	20,00	22,85	27,72	38,14	46,26				23,34
14,10	169 x 114	25,59										
14,20	169 x 114	25,59										
14,25	169 x 114	20,93	20,93		26,42	46,24						
14,29	9/16"	24,79				34,87						
14,30	169 x 114	26,03										
14,40	169 x 114	26,03										
14,50	169 x 114	19,28	19,28		24,71	39,31	51,19	65,60				24,20
14,60	169 x 114	26,51										
14,68	37/64"	19,93				44,04						
14,70	169 x 114	26,51										
14,75	169 x 114	20,93	20,93		30,33	46,24						
14,80	169 x 114	25,55										
14,90	169 x 114	25,55										
15,00	169 x 114	19,45	19,45	21,79	24,94	39,90	53,46	66,57				24,43
15,08	19/32"	18,52				38,00						
15,25	178 x 120	28,49			31,62	63,84						
15,48	39/64"	27,55				60,78						
15,50	178 x 120	22,77	22,77		28,80	46,15	59,65	76,98				26,57
15,75	178 x 120	28,93			32,76	63,82						
15,88	5/8"	22,54				45,62						
16,00	178 x 120	23,67	23,67		29,85	47,90	61,45	80,02				27,09
16,25	184 x 125	42,54			38,43							

BROCAS HELICOIDALES CON MANGO CILÍNDRICO DIN 338



- 10 U.** Ø 0,20 - Ø 10,50 mm
- 6 U.** Ø 10,60 - Ø 14 mm
- 1 U.** Ø 14,10 - Ø 20 mm
- 1 U.** BC9-BC99
BC7-BC98-BC42



		BC01	BC51	BC05	BC95	BC55	BC57	BC50	BC7	BC98	BC42
MATERIAL		HSS	HSSCo 5%	HSSCo 5%	HSSCo 5%	HSSCo 5%	HSSCo 5%	HSSCo 5%	PMD	PMD	MD
AFILADO											
ÁNGULO PUNTA		118°	135°	135°	130°	135°	135°	118°	118°	135°	135°
HÉLICE											
ACABADO		TiN	TiAlN	TiAlSiN	DORADO OX	BRILLANTE	TiAlN	TiAlN	BRILLANTE	BRILLANTE	BRILLANTE
APLICACIÓN		PRODUCCIÓN	ALTA PRODUCCIÓN	ALTA PRODUCCIÓN	INOX	INOX	INOX	INOX Plus	FUNDICIÓN	70 HRc	ALTA PRODUCCIÓN
Ø mm	L1 x L2	€	€	€	€	€	€	€	€	€	€
13,50	160 x 108								59,52		
13,60	160 x 108										
13,70	160 x 108										
13,75	160 x 108										
13,80	160 x 108										
13,89	35/64"										
13,90	160 x 108										
14,00	160 x 108								60,53		
14,10	169 x 114										
14,20	169 x 114										
14,25	169 x 114										
14,29	9/16"										
14,30	169 x 114										
14,40	169 x 114										
14,50	169 x 114								67,60		
14,60	169 x 114										
14,68	37/64"										
14,70	169 x 114										
14,75	169 x 114										
14,80	169 x 114										
14,90	169 x 114										
15,00	169 x 114								69,30		
15,08	19/32"										
15,25	178 x 120										
15,48	39/64"										
15,50	178 x 120								84,18		
15,75	178 x 120										
15,88	5/8"										
16,00	178 x 120								79,95		
16,25	184 x 125										

Brocas Metal

Rosa

Ø 13,50-16,25mm

BROCAS HELICOIDALES CON MANGO CILÍNDRICO DIN 338

Brocas Metal

Gris
Rosa
**DIN
338**

		BC2	BC82	BC02	BC9	BC5	BC99	BC58	BC16	BC66	BC15	BC18
MATERIAL		HSS	HSS	HSS-G	HSS	HSSCo 5%	HSSCo 5%	HSSCo 8%	HSS	HSS	HSS	HSS
AFILADO												
ÁNGULO PUNTA		118°	118°	118°	118°	135°	135°	135°	135°	118°	118°	118°
HÉLICE												
ACABADO		OX	BRILLANTE	DORADO OX	OX	DORADO	DORADO	DORADO	BRILLANTE	BRILLANTE	OX	TiN
APLICACIÓN									Al	LATÓN		PRODUCCIÓN
Ø mm	L1 x L2	€	€	€	€	€	€	€	€	€	€	€
16,50	184 x 125	27,55	27,55		33,44	54,69	70,07					
16,75	184 x 125	44,56			37,71							
17,00	184 x 125	27,58	27,58		33,44	54,69	70,52					
17,25	191 x 130	46,23			42,46							
17,50	191 x 130	31,62	31,62		38,05	60,60	77,63					
17,75	191 x 130	51,20			44,78							
18,00	191 x 130	33,48	33,48		40,12	66,01	85,05					
18,25	198 x 135	50,23			54,65							
18,50	198 x 135	37,14	37,14		44,27	72,90	94,91					
18,75	198 x 135	51,62			50,56							
19,00	198 x 135	37,14	37,14		44,27	72,90	94,09					
19,25	205 x 140	67,45			53,97							
19,50	205 x 140	39,93	39,93		48,05	80,86	104,25					
19,75	205 x 140	65,66			60,44							
20,00	205 x 140	45,35	45,35		57,50	86,77	111,69					
20,50	205 x 140				66,70		120,31					
21,00	205 x 140				60,89		121,96					
21,50	209 x 140				70,81		134,21					
22,00	209 x 140				67,32		136,19					
22,50	214 x 140				72,01		145,66					
23,00	214 x 140				73,72		149,28					
23,50	220 x 145				81,84		165,71					
24,00	220 x 145				80,92		168,17					
24,50	225 x 150				87,18		181,19					
25,00	225 x 150				88,49		180,36					
26,00	243 x 157				106,14		262,46					
27,00	243 x 157				114,00		269,54					
28,00	253 x 167				117,95		296,94					
29,00	253 x 167				138,46		319,37					
30,00	258 x 171				145,55		330,55					

BROCAS HELICOIDALES CON MANGO CILÍNDRICO DIN 338



- 10 U.** Ø 0,20 - Ø 10,50 mm
- 6 U.** Ø 10,60 - Ø 14 mm
- 1 U.** Ø 14,10 - Ø 20 mm
- 1 U.** BC9-BC99
BC7-BC98-BC42



		BC01	BC51	BC05	BC95	BC55	BC57	BC50	BC7	BC98	BC42
MATERIAL		HSS	HSSCo 5%	HSSCo 5%	HSSCo 5%	HSSCo 5%	HSSCo 5%	HSSCo 5%	PMD	PMD	MD
AFILADO											
ÁNGULO PUNTA		118°	135°	135°	130°	135°	135°	118°	118°	135°	135°
HÉLICE											
ACABADO		TiN	TiAlN	TiAlSiN	DORADO OX	BRILLANTE	TiAlN	TiAlN	BRILLANTE	BRILLANTE	BRILLANTE
APLICACIÓN		PRODUCCIÓN	ALTA PRODUCCIÓN	ALTA PRODUCCIÓN	INOX	INOX	INOX	INOX Plus	FUNDICIÓN	70 HRc	ALTA PRODUCCIÓN
Ø mm	L1 x L2	€	€	€	€	€	€	€	€	€	€
16,50	184 x 125								116,88		
16,75	184 x 125										
17,00	184 x 125								87,78		
17,25	191 x 130										
17,50	191 x 130								131,05		
17,75	191 x 130										
18,00	191 x 130								96,52		
18,25	198 x 135										
18,50	198 x 135								156,23		
18,75	198 x 135										
19,00	198 x 135								117,31		
19,25	205 x 140										
19,50	205 x 140								177,80		
19,75	205 x 140										
20,00	205 x 140								133,52		
20,50	205 x 140										
21,00	205 x 140										
21,50	209 x 140										
22,00	209 x 140										
22,50	214 x 140										
23,00	214 x 140										
23,50	220 x 145										
24,00	220 x 145										
24,50	225 x 150										
25,00	225 x 150										
26,00	243 x 157										
27,00	243 x 157										
28,00	253 x 167										
29,00	253 x 167										
30,00	258 x 171										

Brocas Metal
Rosa

Ø 16,50-30mm

BROCAS DE METAL DURO Y REFRIGERACIÓN INTERIOR DIN6537L

Ref. BC97
Ref. BC89

5xD

DIN 6537L

MD

TOL D1 m7

TOL D2 h6



TiAIN

HARDOX 450



Brocas Metal

Rosa

Broca especial para HARDOX 450

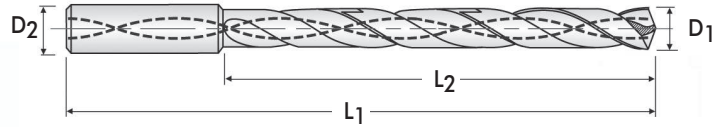

	BC97					BC89		BC97					BC89		
	D1 mm	D2 mm	L1 mm	L2 mm	€		€	D1 mm	D2 mm	L1 mm	L2 mm	€		€	
BC970300	3,0	6	66	28	50,22	BC890300	86,57	BC970880	8,8	10	103	61	71,47	BC890880	112,75
BC970320	3,2	6	66	28	50,22	BC890320	86,57	BC970900	9,0	10	103	61	71,47	BC890900	112,75
BC970350	3,5	6	66	28	50,22	BC890350	86,57	BC970930	9,3	10	103	61	71,47	BC890930	112,75
BC970380	3,8	6	74	36	50,22	BC890380	86,57	BC970950	9,5	10	103	61	71,47	BC890950	112,75
BC970400	4,0	6	74	36	50,22	BC890400	86,57	BC970960	9,6	10	103	61	71,47	BC890960	112,75
BC970420	4,2	6	74	36	50,22	BC890420	86,57	BC970980	9,8	10	103	61	71,47	BC890980	112,75
BC970450	4,5	6	74	36	50,22	BC890450	86,57	BC971000	10,0	10	103	61	71,47	BC891000	112,75
BC970480	4,8	6	82	44	50,22	BC890480	86,57	BC971020	10,2	12	118	71	102,90	BC891020	160,53
BC970500	5,0	6	82	44	50,22	BC890500	86,57	BC971040	10,4	12	118	71	102,90	BC891040	160,53
BC970520	5,2	6	82	44	50,22	BC890520	86,57	BC971050	10,5	12	118	71	102,90	BC891050	160,53
BC970550	5,5	6	82	44	50,22	BC890550	86,57	BC971060	10,6	12	118	71	102,90	BC891060	160,53
BC970560	5,6	6	82	44	50,22	BC890560	86,57	BC971080	10,8	12	118	71	102,90	BC891080	160,53
BC970570	5,7	6	82	44	50,22	BC890570	86,57	BC971100	11,0	12	118	71	102,90	BC891100	160,53
BC970580	5,8	6	82	44	50,22	BC890580	86,57	BC971120	11,2	12	118	71	102,90	BC891120	160,53
BC970590	5,9	6	82	44	50,22	BC890590	86,57	BC971150	11,5	12	118	71	102,90	BC891150	160,53
BC970600	6,0	6	82	44	50,22	BC890600	86,57	BC971180	11,8	12	118	71	102,90	BC891180	160,53
BC970610	6,1	8	91	53	55,00	BC890610	97,00	BC971200	12,0	12	118	71	102,90	BC891200	160,53
BC970620	6,2	8	91	53	55,00	BC890620	97,00	BC971250	12,5	14	124	77	135,25	BC891250	218,04
BC970630	6,3	8	91	53	55,00	BC890630	97,00	BC971300	13,0	14	124	77	135,25	BC891300	218,04
BC970650	6,5	8	91	53	55,00	BC890650	97,00	BC971350	13,5	14	124	77	135,25	BC891350	218,04
BC970660	6,6	8	91	53	55,00	BC890660	97,00	BC971400	14,0	14	124	77	135,25	BC891400	218,04
BC970680	6,8	8	91	53	55,00	BC890680	97,00	BC971450	14,5	16	133	83	169,55	BC891450	273,45
BC970690	6,9	8	91	53	55,00	BC890690	97,00	BC971500	15,0	16	133	83	169,55	BC891500	273,45
BC970700	7,0	8	91	53	55,00	BC890700	97,00	BC971550	15,5	16	133	83	169,55	BC891550	273,45
BC970710	7,1	8	91	53	55,00	BC890710	97,00	BC971600	16,0	16	133	83	169,55	BC891600	273,45
BC970740	7,4	8	91	53	55,00	BC890740	97,00	BC971650	16,5	18	143	93	282,44	BC891650	431,73
BC970750	7,5	8	91	53	55,00	BC890750	97,00	BC971700	17,0	18	143	93	282,44	BC891700	431,73
BC970780	7,8	8	91	53	55,00	BC890780	97,00	BC971750	17,5	18	143	93	282,44	BC891750	431,73
BC970800	8,0	8	91	53	55,00	BC890800	97,00	BC971800	18,0	18	143	93	282,44	BC891800	431,73
BC970810	8,1	10	103	61	71,47	BC890810	112,75	BC971850	18,5	20	153	101	308,72	BC891850	471,90
BC970840	8,4	10	103	61	71,47	BC890840	112,75	BC971900	19,0	20	153	101	308,72	BC891900	471,90
BC970850	8,5	10	103	61	71,47	BC890850	112,75	BC971950	19,5	20	153	101	308,72	BC891950	471,90
BC970860	8,6	10	103	61	71,47	BC890860	112,75	BC972000	20,0	20	153	101	308,72	BC892000	471,90
BC970870	8,7	10	103	61	71,47	BC890870	112,75								

BROCAS DE METAL DURO Y REFRIGERACIÓN INTERIOR DIN6537L
8xD

Ref. BC96

**DIN
6537L**
MD
**TOL D1
m7**
**TOL D2
h6**

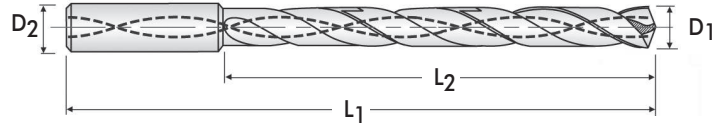
TiAIN
**HARDOX
450**

	BC96				
	D1 mm	D2 mm	L1 mm	L2 mm	€
BC960300	3,00	6	72	34	163,77
BC960320	3,20	6	72	34	163,77
BC960350	3,50	6	72	34	163,77
BC960380	3,80	6	81	43	163,77
BC960400	4,00	6	81	43	163,77
BC960420	4,20	6	81	43	163,77
BC960450	4,50	6	81	43	163,77
BC960480	4,80	6	95	57	163,77
BC960500	5,00	6	95	57	163,77
BC960520	5,20	6	95	57	163,77
BC960550	5,50	6	95	57	163,77
BC960560	5,60	6	95	57	163,77
BC960570	5,70	6	95	57	163,77
BC960580	5,80	6	95	57	163,77
BC960590	5,90	6	95	57	163,77
BC960600	6,00	6	95	57	163,77
BC960610	6,10	8	114	76	178,40
BC960620	6,20	8	114	76	178,40
BC960630	6,30	8	114	76	178,40
BC960650	6,50	8	114	76	178,40
BC960660	6,60	8	114	76	178,40
BC960680	6,80	8	114	76	178,40
BC960690	6,90	8	114	76	178,40
BC960700	7,00	8	114	76	178,40
BC960710	7,10	8	114	76	178,40
BC960740	7,40	8	114	76	178,40
BC960750	7,50	8	114	76	178,40
BC960780	7,80	8	114	76	178,40
BC960800	8,00	8	114	76	178,40
BC960810	8,10	10	142	95	241,56
BC960840	8,40	10	142	95	241,56
BC960850	8,50	10	142	95	241,56
BC960860	8,60	10	142	95	241,56
BC960870	8,70	10	142	95	241,56
BC960880	8,80	10	142	95	241,56
BC960900	9,00	10	142	95	241,56
BC960930	9,30	10	142	95	241,56
BC960950	9,50	10	142	95	241,56
BC960960	9,60	10	142	95	241,56
BC960980	9,80	10	142	95	241,56
BC961000	10,00	10	142	95	241,56
BC961020	10,20	12	162	114	318,47
BC961040	10,40	12	162	114	318,47
BC961050	10,50	12	162	114	318,47
BC961060	10,60	12	162	114	318,47
BC961080	10,80	12	162	114	318,47
BC961100	11,00	12	162	114	318,47
BC961120	11,20	12	162	114	318,47
BC961150	11,50	12	162	114	318,47
BC961180	11,80	12	162	114	318,47
BC961200	12,00	12	162	114	318,47



Broca especial para HARDOX 450

BROCAS DE METAL DURO Y REFRIGERACIÓN INTERIOR DIN6537L

Ref. BXX

12xD

DIN 6537L

MD

TOL D1 m7

TOL D2 h6



TiAIN

HARDOX 450



Brocas Metal

Rosa

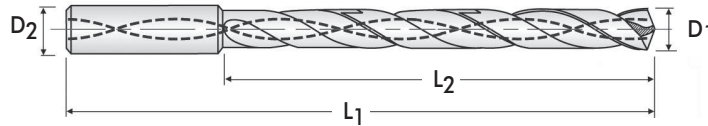

BXX						BXX					
	D1 mm	D2 mm	L1 mm	L2 mm	€		D1 mm	D2 mm	L1 mm	L2 mm	€
BXX0100	1,0	3	55	15	155,25	BXX0670	6,7	8	146	108	230,53
BXX0110	1,1	3	55	23	155,25	BXX0680	6,8	8	146	108	244,62
BXX0120	1,2	3	55	23	155,25	BXX0690	6,9	8	146	108	244,62
BXX0130	1,3	3	55	23	155,25	BXX0700	7,0	8	146	108	244,62
BXX0140	1,4	3	55	23	155,25	BXX0740	7,4	8	146	108	244,62
BXX0150	1,5	3	65	23	155,25	BXX0750	7,5	8	146	108	230,50
BXX0160	1,6	3	65	30	155,25	BXX0770	7,7	8	146	108	230,50
BXX0170	1,7	3	65	30	155,25	BXX0780	7,8	8	146	108	270,00
BXX0180	1,8	3	65	30	155,25	BXX0800	8,0	8	146	108	273,55
BXX0190	1,9	3	65	30	155,25	BXX0820	8,2	10	162	120	305,82
BXX0200	2,0	3	74	30	155,25	BXX0850	8,5	10	162	120	305,82
BXX0210	2,1	3	74	38	155,25	BXX0880	8,8	10	162	120	305,82
BXX0220	2,2	3	74	38	155,25	BXX0900	9,0	10	162	120	305,82
BXX0230	2,3	3	74	38	155,25	BXX0950	9,5	10	162	120	305,82
BXX0240	2,4	3	74	38	155,25	BXX0980	9,8	10	162	120	305,82
BXX0250	2,5	3	81	38	155,25	BXX0990	9,9	10	162	120	305,82
BXX0260	2,6	3	81	44	155,25	BXX1000	10,0	10	162	120	305,82
BXX0270	2,7	3	81	44	155,25	BXX1010	10,1	12	204	156	428,13
BXX0280	2,8	3	81	44	155,25	BXX1020	10,2	12	204	156	428,13
BXX0290	2,9	3	81	44	155,25	BXX1030	10,3	12	204	156	428,13
BXX0300	3,0	6	92	54	176,40	BXX1050	10,5	12	204	156	428,13
BXX0320	3,2	6	92	54	176,40	BXX1080	10,8	12	204	156	428,13
BXX0330	3,3	6	92	54	176,40	BXX1100	11,0	12	204	156	428,13
BXX0350	3,5	6	92	54	176,40	BXX1120	11,2	12	204	156	428,13
BXX0370	3,7	6	92	54	176,40	BXX1140	11,4	12	204	156	428,13
BXX0380	3,8	6	102	64	176,40	BXX1150	11,5	12	204	156	428,13
BXX0390	3,9	6	102	64	176,40	BXX1180	11,8	12	204	156	428,13
BXX0400	4,0	6	102	64	176,40	BXX1200	12,0	12	204	156	428,13
BXX0420	4,2	6	102	64	176,40	BXX1250	12,5	14	230	182	559,85
BXX0430	4,3	6	102	64	176,40	BXX1280	12,8	14	230	182	559,85
BXX0440	4,4	6	102	64	188,19	BXX1300	13,0	14	230	182	559,85
BXX0450	4,5	6	102	64	188,19	BXX1350	13,5	14	230	182	559,85
BXX0460	4,6	6	102	64	188,19	BXX1380	13,8	14	230	182	559,85
BXX0470	4,7	6	102	64	188,19	BXX1400	14,0	14	230	182	559,85
BXX0480	4,8	6	116	78	188,19	BXX1450	14,5	16	260	208	729,18
BXX0490	4,9	6	116	78	188,19	BXX1500	15,0	16	260	208	729,18
BXX0500	5,0	6	116	78	188,19	BXX1550	15,5	16	260	208	729,18
BXX0510	5,1	6	116	78	188,19	BXX1600	16,0	16	260	208	729,18
BXX0520	5,2	6	116	78	188,19						
BXX0530	5,3	6	116	78	188,19						
BXX0540	5,4	6	116	78	188,19						
BXX0550	5,5	6	116	78	188,19						
BXX0560	5,6	6	116	78	188,19						
BXX0570	5,7	6	116	78	188,19						
BXX0580	5,8	6	116	78	188,19						
BXX0590	5,9	6	116	78	188,19						
BXX0600	6,0	6	116	78	188,19						
BXX0610	6,1	8	146	108	230,53						
BXX0620	6,2	8	146	108	230,53						
BXX0650	6,5	8	146	108	230,53						
BXX0660	6,6	8	146	108	230,53						



Broca especial para HARDOX 450

BROCAS DE METAL DURO Y REFRIGERACIÓN INTERIOR DIN6537L
15xD

Ref. BXL

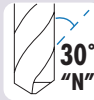
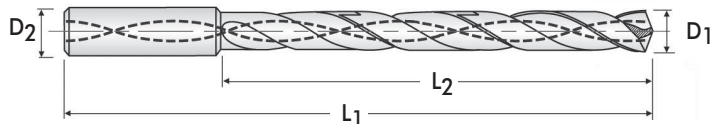
**DIN
6537L**
MD
**TOL D1
m7**
**TOL D2
h6**

TiAIN
**HARDOX
450**

	BXL				
	D1 mm	D2 mm	L1 mm	L2 mm	€
BXL0100	1,0	3	60	20	324,24
BXL0110	1,1	3	60	22	324,24
BXL0120	1,2	3	60	24	324,24
BXL0130	1,3	3	60	25	324,24
BXL0140	1,4	3	60	27	324,24
BXL0150	1,5	3	60	27	324,24
BXL0160	1,6	3	65	32	324,24
BXL0170	1,7	3	65	32	324,24
BXL0180	1,8	3	65	35	324,24
BXL0190	1,9	3	65	35	324,24
BXL0200	2,0	3	65	35	324,24
BXL0210	2,1	3	75	40	324,24
BXL0220	2,2	3	75	40	324,24
BXL0230	2,3	3	75	40	324,24
BXL0240	2,4	3	75	45	324,24
BXL0250	2,5	3	75	45	324,24
BXL0260	2,6	3	80	48	324,24
BXL0270	2,7	3	80	48	324,24
BXL0280	2,8	3	80	50	324,24
BXL0290	2,9	3	80	50	324,24
BXL0300	3,0	6	100	60	410,86
BXL0320	3,2	6	100	60	410,86
BXL0330	3,3	6	100	60	410,86
BXL0350	3,5	6	100	60	410,86
BXL0380	3,8	6	108	68	410,86
BXL0390	3,9	6	108	68	410,86
BXL0400	4,0	6	108	68	410,86
BXL0420	4,2	6	115	78	457,50
BXL0450	4,5	6	115	78	457,50
BXL0500	5,0	6	125	84	470,25
BXL0550	5,5	6	130	92	478,50
BXL0590	5,9	6	140	100	478,50
BXL0600	6,0	6	140	100	478,50
BXL0650	6,5	8	145	108	628,65
BXL0680	6,8	8	170	130	714,91
BXL0700	7,0	8	170	130	714,91
BXL0750	7,5	8	170	130	714,91
BXL0780	7,8	8	170	130	714,91
BXL0800	8,0	8	170	130	714,91
BXL0850	8,5	10	208	163	969,38
BXL0900	9,0	10	208	163	969,38
BXL0950	9,5	10	208	163	969,38
BXL0980	9,8	10	208	163	969,38
BXL1000	10,0	10	208	163	969,38
BXL1050	10,5	12	245	195	1.245,75
BXL1100	11,0	12	245	195	1.245,75
BXL1150	11,5	12	245	195	1.245,75
BXL1180	11,8	12	245	195	1.245,75
BXL1200	12,0	12	245	195	1.245,75
BXL1250	12,5	14	280	230	1.706,54
BXL1300	13,0	14	280	230	1.706,54
BXL1400	14,0	14	280	230	1.706,54
BXL1500	15,0	16	310	260	2.078,16

Broca especial para HARDOX 450



BROCAS MICROMÉTRICAS CON MANGO REFORZADO

Ref. BC30

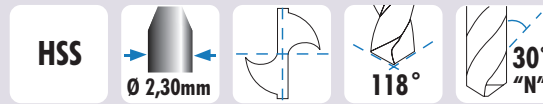

BC30				
	D1 mm	L1 mm	L2 mm	€
BC300050	0,50	43	5	2,78
BC300060	0,60	43	7	2,78
BC300070	0,70	43	7	2,78
BC300075	0,75	43	7	2,78
BC300080	0,80	43	7	2,78
BC300090	0,90	43	7	2,78
BC300095	0,95	43	7	2,78
BC300100	1,00	43	7	2,78
BC300110	1,10	43	7	2,78
BC300120	1,20	43	10	2,78
BC300125	1,25	43	10	2,78
BC300130	1,30	43	10	2,78

BC30				
	D1 mm	L1 mm	L2 mm	€
BC300140	1,40	43	10	2,78
BC300150	1,50	43	10	2,78
BC300160	1,60	43	10	2,78
BC300170	1,70	43	10	2,78
BC300175	1,75	43	10	2,78
BC300180	1,80	43	10	2,78
BC300190	1,90	43	10	2,78
BC300200	2,00	43	10	2,78
BC300210	2,10	43	10	2,78
BC300220	2,20	43	10	2,78
BC300225	2,25	43	10	2,78
BC300235	2,35	43	10	2,78
BC300240	2,40	43	10	2,78

Ref. BC79

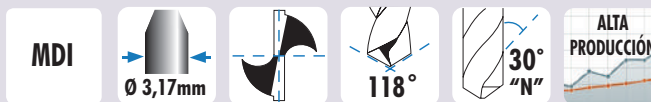

Especial para circuitos impresos.



BC79				
	D1 mm	L1 mm	L2 mm	€
BC790025	0,25	38	5	57,41
BC790030	0,30	38	5	42,39
BC790035	0,35	38	5	19,91
BC790040	0,40	38	5	17,81
BC790045	0,45	38	5	18,01
BC790050	0,50	38	5	12,61
BC790055	0,55	38	5	12,61
BC790060	0,60	38	5	12,61
BC790065	0,65	38	5	11,38
BC790070	0,70	38	10	11,38
BC790075	0,75	38	10	11,38
BC790080	0,80	38	10	11,38
BC790085	0,85	38	10	11,38
BC790090	0,90	38	10	11,38
BC790095	0,95	38	10	11,38
BC790100	1,00	38	10	11,38
BC790105	1,05	38	10	11,38
BC790110	1,10	38	10	11,38
BC790115	1,15	38	10	11,38
BC790120	1,20	38	10	11,38
BC790125	1,25	38	10	11,38
BC790130	1,30	38	10	11,38
BC790135	1,35	38	10	11,38
BC790140	1,40	38	10	11,38
BC790145	1,45	38	10	11,38
BC790150	1,50	38	10	11,38
BC790155	1,55	38	10	11,38
BC790160	1,60	38	10	11,38
BC790165	1,65	38	10	14,30
BC790170	1,70	38	10	14,30

BC79				
	D1 mm	L1 mm	L2 mm	€
BC790175	1,75	38	10	14,30
BC790180	1,80	38	10	14,30
BC790185	1,85	38	10	14,30
BC790190	1,90	38	10	14,30
BC790195	1,95	38	10	14,30
BC790200	2,00	38	10	14,30
BC790205	2,05	38	10	14,30
BC790210	2,10	38	10	14,30
BC790215	2,15	38	10	14,30
BC790220	2,20	38	10	14,30
BC790225	2,25	38	10	14,30
BC790230	2,30	38	10	14,30
BC790235	2,35	38	10	14,30
BC790240	2,40	38	10	14,30
BC790245	2,45	38	10	14,30
BC790250	2,50	38	10	14,30
BC790255	2,55	38	10	14,30
BC790260	2,60	38	10	14,30
BC790265	2,65	38	10	14,30
BC790270	2,70	38	10	14,30
BC790275	2,75	38	10	14,30
BC790280	2,80	38	10	14,30
BC790285	2,85	38	10	14,30
BC790290	2,90	38	10	14,30
BC790295	2,95	38	10	14,30
BC790300	3,00	38	10	14,30
BC790305	3,05	38	10	14,30
BC790310	3,10	38	10	14,30
BC790315	3,15	38	10	14,30

BROCA DE METAL DURO PARA ACEROS TEMPLADOS Y BLINDADOS DE ALTA RESISTENCIA

Brocas Metal

Rosa

Ref. BC85

70 HRC

MD

TOL D1
h7

TOL D2
h6



TiAIN

HARDOX 600



Broca especial para HARDOX 600

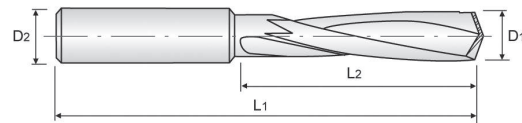

	BC85				
	D1 mm	D2 mm	L1 mm	L2 mm	€
BC850300	3,0	3	46	16	41,45
BC850330	3,3	4	48	18	47,57
BC850340	3,4	4	50	20	47,57
BC850350	3,5	4	50	20	47,57
BC850400	4,0	4	52	22	48,53
BC850420	4,2	6	65	25	68,91
BC850430	4,3	6	68	28	68,91
BC850440	4,4	6	68	28	68,91
BC850450	4,5	6	68	28	68,91
BC850500	5,0	6	72	32	68,91
BC850510	5,1	6	72	32	68,91
BC850520	5,2	6	72	32	68,91
BC850550	5,5	6	75	35	68,91
BC850600	6,0	6	75	35	68,91
BC850650	6,5	8	80	40	76,47
BC850680	6,8	8	85	45	76,47
BC850690	6,9	8	85	45	76,47
BC850700	7,0	8	85	45	76,47
BC850750	7,5	8	85	45	76,47
BC850800	8,0	8	98	50	76,47
BC850850	8,5	10	98	50	116,87
BC850860	8,6	10	105	57	116,87
BC850880	8,8	10	105	57	116,87
BC850900	9,0	10	105	57	116,87
BC850950	9,5	10	105	57	116,87
BC851000	10,0	10	111	63	116,87
BC851020	10,2	12	111	63	151,36
BC851030	10,3	12	111	63	177,60
BC851050	10,5	12	111	63	177,60
BC851080	10,8	12	119	71	177,60
BC851100	11,0	12	119	71	177,60
BC851150	11,5	12	119	71	177,60
BC851200	12,0	12	119	71	177,60
BC851400	14,0	14	125	77	201,81



TALADRADO DE TORNILLOS Y MACHOS ROTOS

Tornillo roto

PASO 1
Limpiar la superficie

PASO 2
Taladrado con la broca BC85

PASO 3
Retirar los restos

PASO 4 (Opcional)
Reparar la rosca con insertos

powercoil
by CELESA

BROCA CUADRADA PARA TALADRAR BOMBILLOS

Ref. BCC06

MD



* Apta para taladrar los pitones "Anti-drilling" de cualquier cilindro.

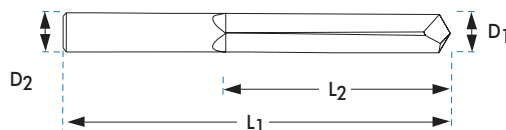

	BCC06				
	D1 mm	D2 mm	L2 mm	L1 mm	€
BCC06X60MD	6	6	33	60	53,02

* Para taladrar cilindros con pitones anti-drilling trabajar a 300RPM



BROCA ANTICHISPA PARA TRABAJOS EN ATMÓSFERAS EXPLOSIVAS (ATEX)

Ref. BACH

22 HRC

Cu-Be

118°

30° "N"

EEx

* Fabricada en Cobre-Berilio, de acuerdo con el estándar Q/ZBF-312
 * Certificados y fichas de seguridad disponibles
 * Apta para trabajar en atmósferas explosivas

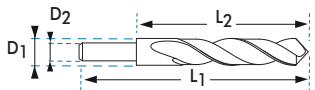

	BACH				
	D1 mm	D2 mm	L1 mm	L2 mm	€
BACH0600	6,0	6,0	100	60	375,45
BACH0700	7,0	7,0	120	80	391,04
BACH0800	8,0	8,0	140	80	415,12
BACH0900	9,0	9,0	160	86	432,83
BACH1000	10,0	10,0	180	108	456,92
BACH1100	11,0	11,0	200	125	472,50
BACH1200	12,0	12,0	220	135	488,09
BACH1300	13,0	12,0	240	150	506,51
BACH1400	14,0	12,0	260	160	522,09
BACH1500	15,0	12,0	280	190	537,67
BACH1600	16,0	12,0	300	195	572,39
BACH1700	17,0	12,0	300	195	600,01
BACH1800	18,0	12,0	320	195	653,14
BACH1900	19,0	12,0	320	205	678,65
BACH2000	20,0	12,0	330	205	716,90

* Especiales bajo demanda

Por sus características especiales de dureza y resistencia (sensiblemente inferiores a los que se pueden obtener en herramientas de acero), las herramientas antichispa no pueden ser garantizadas contra ninguna deformación ni rotura. Sólo se repondrán en concepto de garantía aquellas brocas antichispa cuya dureza sea inferior a 35 HRC.

BROCA DELTABIT TRES CORTES

Ref. BTT33

3Z

DIN 338

HSSCo 5%

135°

30° "N"

TOL H8

Ø ≥ 3

ALTA PRODUCCIÓN

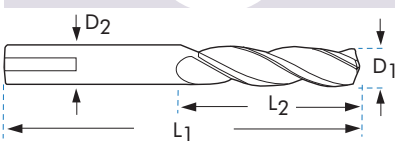

- Mayor precisión de agujero
- Orificios mas redondos y alineados
- Mango triple plano Antideslizante, mayor adherencia al portabrocas

	BTT33			
	D1 mm	L1 mm	L2 mm	€
BTT330300	3,0	61	33	2,41
BTT330330	3,3	65	36	3,11
BTT330350	3,5	70	39	3,11
BTT330400	4,0	75	43	3,65
BTT330420	4,2	75	43	4,51
BTT330450	4,5	80	47	4,51
BTT330500	5,0	86	52	5,16
BTT330550	5,5	93	57	6,40
BTT330600	6,0	93	57	7,39
BTT330650	6,5	101	63	8,49
BTT330680	6,8	109	69	9,77
BTT330700	7,0	109	69	9,77

	BTT33			
	D1 mm	L1 mm	L2 mm	€
BTT330750	7,5	109	69	11,15
BTT330800	8,0	117	75	13,33
BTT330850	8,5	117	75	14,83
BTT330900	9,0	125	81	17,20
BTT330950	9,5	125	81	18,73
BTT331000	10,0	133	87	21,10
BTT331020	10,2	133	87	23,50
BTT331050	10,5	133	87	23,50
BTT331100	11,0	142	94	27,06
BTT331150	11,5	142	94	29,26
BTT331200	12,0	151	101	33,85
BTT331250	12,5	151	101	36,22
BTT331300	13,0	151	101	38,60

BROCA XTURBO CON PUNTA CENTRADORA

Ref. BTX

DIN
338
HSSCo
5%
TOL
H8

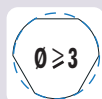
120
Kg/mm²

 $\varnothing \geq 3$

135°

38°
"S"

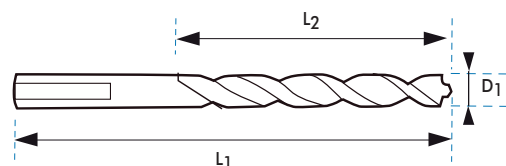
- Broca XTURBO con punta centradora, mejora la embocadura y facilita la penetración de la broca.
- Geometría revolucionaria, mejora la calidad de agujero evitando la generación de rebabas e imperfecciones.
- Aumenta el volumen de evacuación de viruta debido al canal de su hélice de mayor profundidad.
- Agujeros perfectos, mas redondos y precisos.
- Mango triple plano Antislip, ajuste sólido al portabrocas.



	BTX			
	D1 mm	L1 mm	L2 mm	€
*BTX0300F	3,0	61	33	1,85
*BTX0320F	3,2	65	36	2,27
*BTX0330F	3,3	65	36	2,27
*BTX0350F	3,5	70	39	2,27
*BTX0400F	4,0	75	43	2,29
*BTX0420F	4,2	75	43	2,73
*BTX0450F	4,5	80	47	2,80
BTX0500F	5,0	86	52	3,77
BTX0550F	5,5	93	57	4,78
BTX0600F	6,0	93	57	5,08
BTX0650F	6,5	101	63	5,93
BTX0680F	6,8	109	69	6,91
BTX0700F	7,0	109	69	6,49
BTX0750F	7,5	109	69	6,89
BTX0800F	8,0	117	75	8,07
BTX0850F	8,5	117	75	8,42
BTX0900F	9,0	125	81	10,73
BTX0950F	9,5	125	81	11,11
BTX1000F	10,0	133	87	12,22
BTX1020F	10,2	133	87	16,50
BTX1050F	10,5	133	87	16,51
BTX1100F	11,0	142	94	18,22
BTX1150F	11,5	142	94	20,97
BTX1200F	12,0	151	101	22,48
BTX1250F	12,5	151	101	27,44
BTX1300F	13,0	151	101	27,84

* Afilado autocentrante, Split Point.



(Brocas Ref. BTX)

REFERENCIA	PTX010	PTX011
Nº BROCAS	19	25
CALIDAD	HSSCo 5%	HSSCo 5%
CONTENIDO	\varnothing 1-10 x 0,50 mm	\varnothing 1-13 x 0,50 mm
P.V.P. €	115,36	210,25

DIN 340

DIN 1897

		BC4	BC47	BC40	BC44	BC48	BC78										
		HSS	HSSCo 5%	HSS	HSSCo 5%	HSSCo 5%	PMD										
		118°	135°	118°	135°	135°	118°										
		30° "N"	30° "N"	30° "N"	38° "5"	38° "5"	30° "N"										
		OX	DORADO	TiN	BRILLANTE	TiAlN	BRILLANTE										
				PRODUCCIÓN	INOX	INOX	FUNDICIÓN										
Ø mm	L1 x L2	€	€	€	€	€	€	L1 x L2	€	€	€	€	€	€	€	€	€
2,75	100x66	3,44						46x16	0,92	2,01	2,23						
2,80	100x66	3,35				9,08		46x16	1,08	1,94	2,39				12,27		
2,90	100x66	3,35				9,07		46x16	1,08	1,94	2,39				12,27		
3,00	100x66	2,33	4,58	3,44	7,26	9,20	27,69	46x16	0,92	1,66	2,23	3,10	4,40	15,94	11,15	1,72	
3,10	106x69	2,59	5,18	4,02	8,33	10,79		49x18	1,00	1,74	2,55	3,45			12,47	1,72	
3,20	106x69	2,59			8,35	10,73		49x18	1,00	1,74	2,55	3,45			12,47	1,72	
3,25	106x69	2,59	5,18	4,02				49x18	1,00	1,74	2,55			20,98		1,72	2,47
3,30	106x69	2,59			8,37	10,70		49x18	1,01	1,74	2,56	3,45	5,44		12,47	1,72	
3,40	112x73	3,36			10,59			52x20	1,13	2,15	2,69	3,35		20,98	13,42	1,92	
3,50	112x73	2,46	5,40	3,84	8,63	11,04	26,51	52x20	1,00	1,74	2,55	3,65	5,41	15,94	12,52	1,92	3,07
3,60	112x73	3,36			10,06			52x20	1,26	2,15	2,82	4,21			14,75		
3,70	112x73	3,36			10,43			52x20	1,26	2,15	2,82	4,21	6,05		14,75		
3,75	112x73	3,48	6,15	4,87				52x20	1,11	2,22	2,67					2,19	
3,80	119x78	4,17			12,53			55x22	1,26	2,15	2,82	4,22			15,88	2,12	
3,90	119x78	4,17			11,07			55x22	1,26	2,15	2,82	4,22			15,88		
4,00	119x78	2,67	5,58	4,07	8,85	11,32	27,47	55x22	1,11	1,96	2,67	4,04	5,64	15,91	14,84	1,95	3,14
4,10	119x78	3,49			9,83	12,19		55x22	1,32	2,34	2,87	4,40			16,67	2,12	
4,20	119x78	3,49			9,84	12,26		55x22	1,32	2,34	2,87	4,45	6,17	18,65	16,67	2,12	
4,25	119x78	3,49	6,14	4,87				55x22	1,32	2,34	2,87					2,12	
4,30	126x82	4,52		4,87	10,95	13,28		58x24	1,51	2,68	3,07	4,73			17,68		
4,40	126x82	4,52			11,40			58x24	1,51	2,68	3,07	4,88			17,68		
4,50	126x82	3,17	6,84	4,61	10,86	13,38	28,08	58x24	1,32	2,34	2,87	4,54	6,27	17,42	17,17	2,19	
4,60	126x82	4,48			14,67			58x24	1,70	2,80	3,26	5,45			17,68		
4,70	126x82	4,48			10,89			58x24	1,70	2,80	3,26	5,24			18,94		
4,75	126x82	4,69	6,87	6,09				58x24	1,46	2,60	3,02					3,54	
4,80	132x87	5,21			11,40			62x26	1,70	2,80	3,26	5,32			18,94		
4,90	132x87	5,21			15,81			62x26	1,70	2,80	3,26	5,45			18,94		
5,00	132x87	3,41	6,84	4,81	11,03	13,38	28,34	62x26	1,46	2,59	3,02	4,96	6,60	18,84	18,15	2,51	4,01
5,10	132x87	5,21			12,80	15,18		62x26	1,87	3,19	3,43	5,70		23,96	18,94	3,40	
5,20	132x87	5,21			12,83		30,74	62x26	1,86	3,16	3,41	5,87			24,54	3,40	
5,25	132x87	5,43	8,13	6,79				62x26	1,62	2,89	3,17					3,54	
5,30	132x87	5,66			13,32	15,72		62x26	1,88	3,16	3,44	6,02			24,54		
5,40	139x91	5,66			18,57			66x28	1,88	3,16	3,44	6,20			24,54		
5,50	139x91	4,50	9,41	5,88	14,88	17,27	30,74	66x28	1,62	2,89	3,17	5,88	7,69	22,51	23,81	3,02	
5,60	139x91	5,67			15,28			66x28	2,15	3,37	3,71	6,51			26,07		
5,70	139x91	5,67		7,26	12,14			66x28	2,16	3,37	3,72	6,72		25,01	26,07		
5,75	139x91	5,89	9,46	7,26				66x28	1,82	3,50	3,37					4,20	
5,80	139x91	6,23			15,57			66x28	2,15	3,37	3,71	6,52			26,07		
5,90	139x91	6,23			15,86			66x28	2,16	3,37	3,72	6,50			26,07		
6,00	139x91	4,16	9,41	5,51	14,94	17,41	30,71	66x28	1,85	3,29	3,41	6,28	8,06	24,61	26,54	3,41	
6,10	148x97	6,23			20,91			70x31	2,53	4,25	4,89	7,67		25,66	32,46		
6,20	148x97	6,23			19,52			70x31	2,53	4,25	4,89	7,55			32,46		
6,25	148x97	6,48		8,50				70x31	2,19	4,39	4,56						
6,30	148x97	6,30						70x31	2,53	4,25	4,89	7,83			32,46		
6,40	148x97	6,30						70x31	2,53	4,22	4,89	7,84			32,46		
6,50	148x97	5,36	10,80	9,03	17,25	23,58	33,06	70x31	2,18	3,92	6,35	7,56	12,30	25,74	31,22		
6,60	148x97	6,30						74x34	2,94	5,30	7,11	8,82			38,19		
6,70	148x97	6,30			16,20			74x34	2,94	5,30	7,11	8,82			38,19		
6,75	156x102	6,55	12,45	10,19				74x34	2,50	5,47	6,67						
6,80	156x102	6,53			20,03	26,49		74x34	2,55	5,45	6,72	8,66	15,17	32,46	38,19		
6,90	156x102	6,69						74x34	2,80					28,63	38,19		

BROCAS HELICOIDALES CON MANGO CILÍNDRICO, SERIE LARGA Y EXTRACORTA

DIN
340



DIN
1897



Brocas Metal

Rosa

	BC4	BC47	BC40	BC44	BC48	BC78		BC3	BC31	BC37	BC33	BC35	BC77	BC43	BC17	BC38
MATERIAL	HSS	HSSCo 5%	HSS	HSSCo 5%	HSSCo 5%	PMD		HSS	HSSCo 5%	HSS	HSSCo 5%	HSSCo 5%	PMD	MD	HSS	HSSCo 5%
AFILADO																
ÁNGULO PUNTA	118°	135°	118°	135°	135°	118°		135°	135°	135°	135°	118°	118°	135°	135°	135°
HÉLICE	30° "N"	30° "N"	30° "N"	38° "5"	38° "5"	30° "N"		30° "N"	30° "N"	30° "N"	38° "5"	38° "N"	30° "N"	35° "N"	30° "N"	30° "N"
ACABADO	OX	DORADO	TiN	BRILLANTE	TiAlN	BRILLANTE		OX	DORADO	TiN	BRILLANTE	TiAlN	BRILLANTE	BRILLANTE	OX	DORADO
APLICACIÓN			PRODUCCIÓN	INOX	INOX	FUNDICIÓN				PRODUCCIÓN	INOX	INOX Plus	FUNDICIÓN	ALTA PRODUCCIÓN		
Ø mm	L1 x L2	€	€	€	€	€	L1 x L2	€	€	€	€	€	€	€	€	€
7,00	156x102	6,23	12,61	9,96	20,11	26,90	33,06	74x34	2,55	4,49	6,72	8,64	13,22	28,27	36,69	4,45
7,10	156x102	6,69						74x34							46,53	
7,20	156x102	6,69			24,43			74x34	3,30						45,63	
7,25	156x102	6,97						74x34	2,89	5,86	7,05					
7,30	156x102	6,84			24,43			74x34		5,86					46,53	
7,40	156x102	6,84						74x34							46,53	
7,50	156x102	6,64	13,40	10,32	21,44	28,12	37,67	74x34	2,89	5,47	7,05	10,32	15,65	29,70	41,16	
7,60	165x109	6,84						79x37		6,33					51,50	
7,70	165x109	6,84						79x37		6,33					52,50	
7,75	165x109	7,10		10,01				79x37	3,18	6,33	7,35					
7,80	165x109	7,64			29,47			79x37	3,64	6,54	7,81	11,22	23,71		51,50	
7,90	165x109	7,64						79x37		6,54					51,50	
8,00	165x109	7,33	14,84	11,12	23,80	30,29	37,67	79x37	3,15	5,66	7,32	10,80	15,47	31,69	48,27	5,49
8,10	165x109	7,64						79x37						35,25	62,80	
8,20	165x109	7,64			26,78			79x37							64,03	
8,25	165x109	7,95						79x37	3,79	7,47	7,96					
8,30	165x109	11,67						79x37							64,03	
8,40	165x109	11,76						79x37							64,03	
8,50	165x109	8,23	16,62	12,58	26,34	34,39	47,67	79x37	3,79	6,70	7,96	12,57	18,32	34,78	61,89	
8,60	175x115	11,76						84x40		8,11				36,11	68,15	
8,70	175x115	11,76						84x40							69,47	
8,75	175x115	12,22		12,85				84x40	4,14	8,11	8,30					
8,80	175x115	12,01			28,60			84x40							68,15	
8,90	175x115	12,01						84x40							69,47	
9,00	175x115	8,93	18,01	13,23	28,92	36,66	41,66	84x40	4,11	7,35	8,97	13,66	19,44	37,05	58,44	

BROCAS HELICOIDALES CON MANGO CILÍNDRICO SERIE EXTRALARGA
**DIN
1869
I/II/III**

Ref. BC8



Ref. BC88

		BC8	BC88			BC8	BC88			BC8	BC88
MATERIAL		HSS	HSSCo 5%	Ø mm	L1 x L2	€	€	Ø mm	L1 x L2	€	€
AFILADO											
ÁNGULO PUNTA	118°	135°									
HÉLICE	30° "N"	38° "45"									
ACABADO	OX	BRILLANTE									
APLICACIÓN	70 Kg/mm ²	INOX									
Ø mm	L1 x L2	€	€								
1,00	100x60	14,81		5,50	205x140	19,51	22,67	9,25	320x220		98,03
1,50	140x45	11,95		5,50	260x180	27,79	34,30	9,25	410x280		122,59
2,00	125x85	11,49	15,71	5,50	330x225	32,22	42,17	9,50	250x175	46,54	65,75
2,25	135x90		20,00	5,75	205x140	23,55	28,08	9,50	320x220	64,32	85,35
2,50	140x95	12,10	15,71	5,75	260x180	32,57	38,82	9,50	410x280	86,47	113,45
2,75	150x100		21,92	5,75	330x225	39,88	47,11	9,75	265x185		78,44
3,00	150x100	12,43	17,85	6,00	205x140	19,48	22,66	9,75	340x235		102,14
3,00	190x130	14,43	21,96	6,00	260x180	27,95	34,30	9,75	430x295		131,65
3,25	155x105		21,92	6,00	330x225	32,10	42,30	10,00	265x185	46,31	59,60
3,25	200x135		27,07	6,25	215x150		32,91	10,00	340x235	60,23	78,47
3,50	165x115	14,11	18,09	6,25	275x190		40,62	10,00	430x295	83,66	110,61
3,50	210x145	16,22	23,25	6,25	350x235		52,44	10,25	265x185		116,22
3,50	265x180	23,11	31,53	6,50	215x150	23,10	28,09	10,25	340x235		126,00
3,75	165x115		25,39	6,50	275x190	29,89	37,85	10,25	430x295		133,99
3,75	210x145		27,07	6,50	350x235	37,24	48,31	10,50	265x185	85,32	100,76
3,75	265x180		35,74	6,75	225x155		35,74	10,50	340x235	92,46	109,22
4,00	175x120	13,98	18,09	6,75	290x200		46,91	10,50	430x295	98,34	116,15
4,00	220x150	16,61	23,25	6,75	370x250		66,52	10,75	280x195		116,22
4,00	280x190	23,68	31,53	7,00	225x155	24,57	34,85	10,75	365x250		126,00
4,25	175x120		26,90	7,00	290x200	34,19	42,30	10,75	455x310		133,99
4,25	220x150	28,91	34,77	7,00	370x250	46,20	62,31	11,00	280x195	58,42	75,55
4,25	280x190		43,49	7,25	225x155		45,53	11,00	365x250	83,02	98,07
4,50	185x125	15,65	21,17	7,25	290x200		56,13	11,00	455x310	97,20	114,78
4,50	235x160	19,47	27,62	7,25	370x250		74,98	11,25	280x195		108,26
4,50	295x220	27,83	39,24	7,50	225x155	27,63	38,45	11,25	365x250		145,33
4,75	185x125		27,69	7,50	290x200	36,84	50,40	11,25	455x310		150,12
4,75	235x160		34,77	7,50	370x250	53,64	70,76	11,50	280x195	79,44	93,85
4,75	295x200		43,49	7,75	240x165		46,91	11,50	365x250	106,66	125,99
5,00	195x135	16,40	28,43	7,75	305x210		56,13	11,50	455x310	110,21	130,15
5,00	245x170	20,93	32,14	7,75	390x265		82,94	11,75	280x195		108,26
5,00	315x210	25,79	37,09	8,00	240x165	30,54	39,24	11,75	365x250		145,33
5,25	195x135		28,08	8,00	305x210	42,36	49,09	11,75	455x310		150,12
5,25	245x170		38,82	8,00	390x265	55,19	72,68	12,00	295x205	76,86	85,35
5,25	315x210		46,53	8,25	240x165		61,52	12,00	375x260	93,67	110,61
				8,25	305x210		81,67	12,00	480x330	113,98	134,61
				8,25	390x265		99,21	12,25	295x205		126,00
				8,50	240x165	41,53	53,24	12,25	375x260		141,10
				8,50	305x210	56,69	74,24	12,25	480x330		171,27
				8,50	390x265	77,41	90,92	12,50	295x205	92,46	109,22
				8,75	240x165		65,74	12,50	375x260	103,55	122,30
				8,75	320x220		81,67	12,50	480x330	125,70	148,44
				8,75	410x280		104,44	12,75	295x205		126,00
				9,00	250x175	39,69	56,81	12,75	375x260		141,10
				9,00	320x220	52,13	71,38	12,75	480x330		171,27
				9,00	410x280	76,95	96,53	13,00	295x205	92,46	109,22
				9,25	250x175		76,87	13,00	375x260	106,68	125,99
								13,00	480x330	126,88	149,85

* Longitudes especiales bajo demanda.

BROCA HELICOIDAL PARA AERONÁUTICA, SERIE EXTRA LARGA

Ref. BC08

HSS

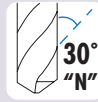
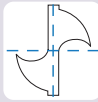

AIRCRAFT

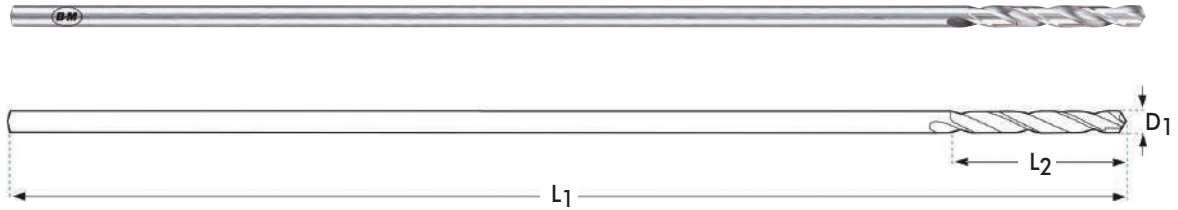

150 mm

				BC08
	D1 mm	L1 mm	L2 mm	€
BC080225150	2,25	150	25	12,57
BC080250150	2,50	150	25	12,13
BC080320150	3,20	150	26	12,11
BC080325150	3,25	150	36	11,93
BC080400150	4,00	150	43	12,34

300 mm

				BC08
	D1 mm	L1 mm	L2 mm	€
BC080225300	2,25	300	25	13,35
BC080250300	2,50	300	25	12,61
BC080320300	3,20	300	26	12,65
BC080325300	3,25	300	36	12,60
BC080400300	4,00	300	43	14,10

* Otras dimensiones disponibles bajo demanda

BROCA DE METAL DURO HELICOIDAL PARA AERONÁUTICA, SERIE EXTRALARGA

Ref. BC08PMD

PMD

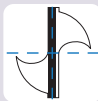

AIRCRAFT MD

85°

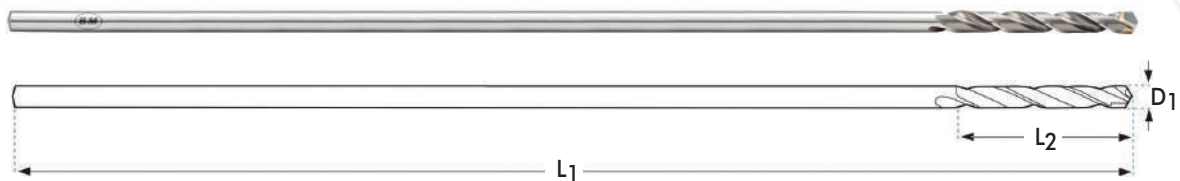

* Disponibilidad serie Aircraft MD. Fabricación de medidas especiales bajo demanda.

BROCAS DE CENTRAR

 Ref. BC10
 Ref. BC10Co

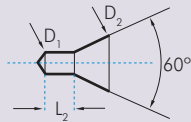
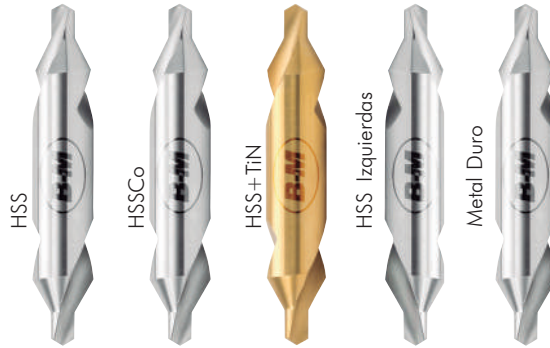
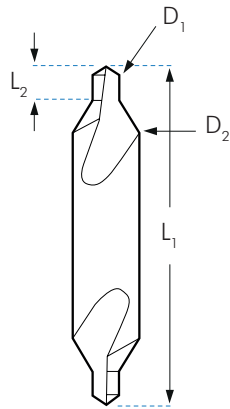
 Ref. BC65
 Ref. BC10I
 Ref. BC10MD

**DIN
333A**

D1 x D2 mm	L1 x L2 mm	BC10	BC10Co	BC65	BC10I	BC10MD
		HSS	HSSCo 5%	TiN	HSS	MD
		€	€	€	€	€
0,50 x 3,00	31 x 1	12,11				
0,50 x 3,15	25 x 1	7,11	7,74	12,21		
0,63 x 3,15	25 x 1	7,11				55,31
0,80 x 3,15	25 x 1	6,99	7,74	12,09		
1,00 x 3,15	31 x 1	5,18	7,74	10,28		52,68
1,25 x 3,15	33 x 1	5,18	7,74	10,28		52,68
0,75 x 3,50	35 x 1	7,56	7,74	12,66		
1,00 x 4,00	35 x 1	6,50	7,74	11,60		59,07
1,25 x 4,00	35 x 1	5,50		10,98		
1,50 x 5,00	40 x 2	6,25	8,33	12,40		60,25
1,60 x 4,00	37 x 2	5,18	7,74	10,68	8,02	56,26
1,60 x 5,00	40 x 2	5,47		11,59		
2,00 x 5,00	42 x 2	5,57	8,33	11,69	8,63	64,11
2,00 x 6,00	45 x 2	6,25	8,77	12,80		68,36
2,00 x 6,30	45 x 2	5,62		12,59	9,15	
2,50 x 6,30	47 x 3	6,18	9,25	12,74	9,59	73,06
2,50 x 8,00	50 x 3	6,83	9,25	13,36	10,58	86,07
3,00 x 8,00	50 x 3	6,83	9,75	13,38		86,07
3,15 x 8,00	52 x 4	6,80	10,17	13,36	10,55	81,97
3,00 x 10,00	55 x 4	8,88	13,48	15,88		102,13
3,15 x 10,00	56 x 4	8,04			12,47	
4,00 x 10,00	59 x 5	9,44	13,48	18,02	14,63	102,13
4,00 x 12,00	63 x 5	15,25	21,25	23,25		
4,00 x 12,50	63 x 5	10,99			17,04	
5,00 x 12,00	63 x 5	15,25	21,25	23,25		165,44
5,00 x 12,50	66 x 6	16,56	22,22	24,66	25,67	170,57
5,00 x 14,00	69 x 6	26,23	29,36	35,33		
5,00 x 16,00	71 x 6	26,23			40,65	
6,30 x 16,00	74 x 8	22,65	31,80	32,15		272,49
6,00 x 18,00	77 x 8	39,92				
6,30 x 20,00	80 x 8	39,92				
8,00 x 20,00	81 x 27	43,72	87,01	65,05		
8,00 x 25,00	100 x 10	95,36				
10,00 x 25,00	100 x 31	67,85	95,76	97,41		
10,00 x 31,50	125 x 12	201,25				
12,50 x 31,50	125 x 33	161,39	209,75	210,95		

BROCAS DE CENTRAR

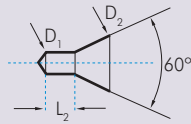
Ref. BC64
Ref. BC68



**DIN
333A**

SERIE LARGA



D1 x D2 mm	L1 x L2 mm	BC64		BC68	
		HSS €	TiN €	HSS €	TiN €
1,00 x 4,00	60 x 1	17,73	26,89		
1,00 x 4,00	120 x 1	35,82	68,40		
1,50 x 5,00	60 x 2	18,08	27,24		
1,50 x 5,00	120 x 2	36,51	60,52		
2,00 x 5,00	200 x 2	74,67	133,67		
2,00 x 6,00	80 x 2	18,84	29,58		
2,00 x 6,00	120 x 2	28,54	59,81		
2,50 x 6,30	200 x 2	73,33	132,33		
2,50 x 8,00	80 x 3	22,92	38,46		
2,50 x 8,00	120 x 3	34,71	70,90		
3,00 x 8,00	80 x 4	22,92	38,46		
3,00 x 8,00	120 x 4	34,71	70,90		
3,15 x 8,00	200 x 4	69,33	128,33		
3,00 x 10,00	100 x 4	29,60	48,37		
3,00 x 10,00	120 x 4	35,86	80,24		
4,00 x 10,00	100 x 5	29,63	48,37		
4,00 x 10,00	120 x 5	35,91	80,24		
4,00 x 10,00	200 x 5	76,00	135,00		
4,00 x 12,00	100 x 5	39,91	72,24		
4,00 x 12,00	120 x 5	48,35	102,17		
5,00 x 14,00	120 x 6	67,69	123,13		

Ref. BC62

**DIN
333R**

HSS

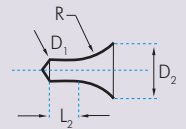

D1 x D2 mm	L1 x L2 mm	BC62 €
1,00 x 3,15	31 x 3	5,65
1,25 x 3,15	31 x 3	5,65
1,25 x 4,00	35 x 3	5,65
1,60 x 4,00	37 x 4	5,65
1,60 x 5,00	40 x 4	6,37
2,00 x 5,00	42 x 5	6,15
2,00 x 6,30	45 x 6	7,13
2,50 x 6,30	47 x 6	6,84
2,50 x 8,00	50 x 7	7,51
3,15 x 8,00	52 x 8	7,51
3,15 x 10,00	56 x 9	9,79
4,00 x 10,00	56 x 10	9,79
4,00 x 12,50	63 x 11	16,31
5,00 x 12,50	66 x 13	16,35
5,00 x 16,00	71 x 15	23,21
6,30 x 16,00	74 x 17	23,49
6,30 x 20,00	80 x 19	41,64
8,00 x 20,00	80 x 21	44,63
10,00 x 25,00	100 x 31	73,93
12,50 x 31,50	125 x 33	168,64



Ref. BC63

**DIN
333B**

HSS

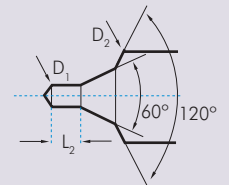

D1 x D2 mm	L1 x L2 mm	BC63 €
1,00 x 4,00	37,50 x 1,60	9,48
1,25 x 5,00	42,00 x 1,90	9,48
1,60 x 6,30	47,00 x 2,40	9,48
2,00 x 8,00	52,00 x 2,90	9,94
2,50 x 10,00	59,00 x 3,60	11,50
3,15 x 11,20	63,00 x 4,40	13,29
4,00 x 14,00	70,00 x 5,60	20,44
5,00 x 18,00	78,00 x 6,90	28,26
6,30 x 20,00	83,00 x 8,60	41,22
8,00 x 25,00	100,00 x 26,00	91,05
10,00 x 31,50	125,00 x 30,00	180,42

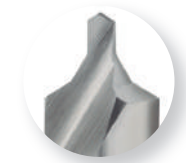

BROCAS DE PUNTEAR

Utilizadas para el centrado previo de los taladros realizados con broca. Prepara la embocadura de la broca. Incrementa la velocidad de ataque en el taladrado.

DIN 1412A D₂

TOL h6

Ref. BC75
Ref. BI75
Ref. BC76

HSSCo 5%

TiAIN



BROCA DE PUNTEAR DOBLE PUNTA

Ref. DP75

HSSCo 5%

TiAIN



- Ref. BC75 90°
- Ref. BI75 90°
- Ref. BC76 120°



		DP75	
		90°	
D x d mm	L mm	€	
3,0 x 0,5	40	23,61	
4,0 x 1,0	45	23,71	
6,0 x 2,0	55	26,89	
8,0 x 2,5	65	31,06	
10,0 x 3,0	75	33,33	
12,0 x 3,5	85	41,11	
16,0 x 4,0	90	63,33	
20,0 x 5,0	100	103,89	

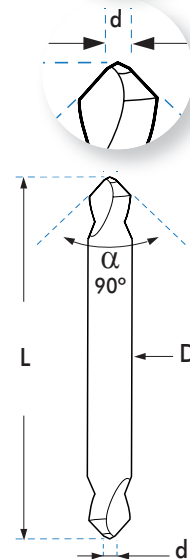

D1=D2 mm	L1 x L2 mm	BC75	BI75	BC76
		90°	90°	120°
		€	€	€
2	49 x 8	16,36		16,36
3	50 x 10	18,92	58,33	18,92
4	52 x 12	18,92	62,22	18,92
5	60 x 15	21,34	66,11	21,34
6	66 x 20	21,34	70,00	21,34
8	79 x 25	24,10	77,78	24,10
10	89 x 25	24,10	87,50	24,10
12	102 x 30	33,23	97,22	33,23
16	115 x 35	45,72		45,72
20	131 x 40	89,96		89,96

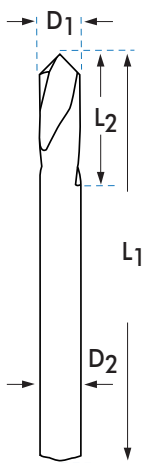

BROCA DE PUNTEAR METAL DURO

Ref. BC92
Ref. BC93

MD

DIN 1412A

TOL h6

DIN 6535HB

D₂

D₂

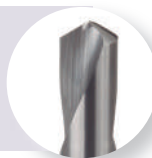

Ref. BN75

HSSCo 5%

120 Kg/mm²

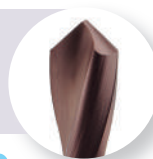

Ti

INC

Ni

INOX

PVC

- 90°
- 120°



APLICACIÓN MULTITAREA

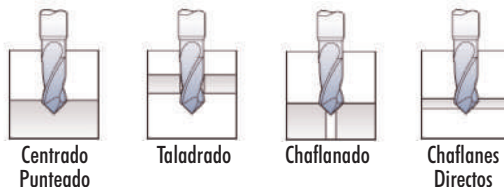

D1=D2 mm	L1 x L2 mm	BC92	BC93
		90°	120°
		€	€
1,0	26 x 6	24,61	
1,5	32 x 9	24,97	
2,0	38 x 12	25,23	
3,0	45 x 12	25,59	26,32
4,0	50 x 15	25,85	26,59
5,0	50 x 18	30,80	31,68
6,0	50 x 13	39,94	41,08
8,0	60 x 23	56,23	57,83
10,0	70 x 24	79,72	81,99
12,0	70 x 24	102,92	105,86
14,0	70 x 27	154,99	159,42
16,0	75 x 29	189,40	183,99
18,0	100 x 33	282,25	290,31
20,0	100 x 35	334,23	326,24

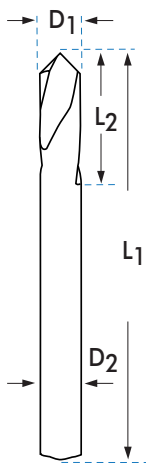

BN75				
90°				
	D mm	L1 x L2 mm	T*	€
BN750300	3,0	50 x 6	0,3	27,94
BN750400	4,0	52 x 8	0,4	30,29
BN750500	5,0	60 x 10	0,5	32,90
BN750600	6,0	66 x 12	0,6	35,25
BN750800	8,0	79 x 14	0,8	42,56
BN751000	10,0	89 x 16	1,0	50,92
BN751200	12,0	102 x 18	1,2	66,58
BN751400	14,0	115 x 21	1,4	94,00
BN751600	16,0	115 x 24	1,6	104,44

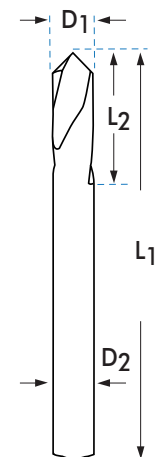

T*: Espesor del núcleo

BROCAS DE PUNTEAR

Utilizadas para el centrado previo de los taladros realizados con broca. Prepara la embocadura de la broca. Incrementa la velocidad de ataque en el taladrado.

DIN
1412A

D₂

TOL
h6

HSSCo
5%

TiAIN

Ref. BL75



BL75		
HSSCo 5%	TiAIN	90°
D1 mm	L1 x L2 mm	€
3	80 x 10	38,89
4	100 x 12	42,78
5	120 x 15	46,67
6	140 x 20	50,56
8	140 x 25	56,39
10	170 x 25	70,00
12	170 x 30	85,56
16	200 x 35	114,72
20	200 x 40	145,83

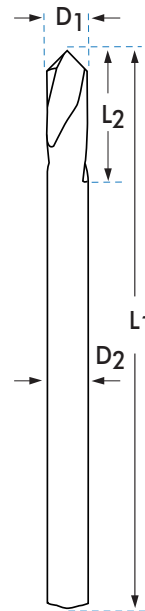

BROCAS DE PUNTEAR MANGO CÓNICO

HSSCo
5%

120
Kg/mm²

Ref. BP11



BP11					
90°					
D1 mm	L1 mm	L2 mm	L3 mm	CM	€
10	130	25	64	1	116,67
12	130	30	64	1	126,39
16	148	35	68	2	155,56
20	148	40	68	2	194,44
25	171	45	72	3	262,50

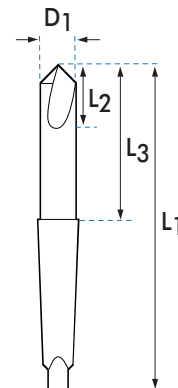

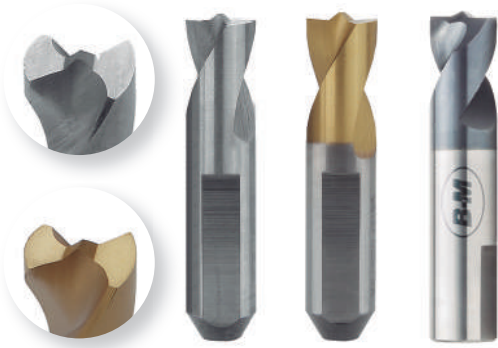
BROCAS PARA QUITAR PUNTOS DE SOLDADURA
BROCA CORTA PARA MÁQUINAS NEUMÁTICAS

D1 mm	D2 mm	L1 x L2 mm	BC70	BC71	BC70MD*
			HSSCo 5%	HSSCo 5% TiN	MD TiAlN
			€	€	€
6,0	8,0	45 x 18	22,54	30,56	
6,5	6,5	40 x 18	23,50	34,99	57,33
8,0	8,0	38 x 18	18,47	30,56	
8,0	8,0	45 x 18	20,60	34,99	69,94
9,0	8,0	45 x 18	22,25	36,36	
10,0	8,0	45 x 18	24,39	41,25	

*** BROCA ESPECIAL BC70MD METAL DURO + TiAlN**

- Broca especial para **soldaduras al Boro**.
- Usar con taladros eléctricos, no neumáticos.
- 1200 RPM.
- Esfuerzos de empuje altos.
- Siempre con "CUT-MAGIC".

BROCA LARGA PARA MÁQUINAS ELECTROPORTÁTILES

Ø mm	L1 x L2 mm	BC60	BC69
		HSSCo 5%	HSSCo 5% TiN
		€	€
6,0	66 x 26	11,14	19,55
7,0	74 x 34	15,98	25,44
8,0	79 x 36	14,77	27,56
10,0	89 x 44	18,25	29,13

CONJUNTO CORTADOR: HUSILLO, CORONA Y PUNZÓN

EBC70-1
 21,23 €

CORONA CORTADORA: DE 9 mm

EBC70-2
 15,35 €

PUNZÓN GUÍA

EBC70-3
 0,93 €

EBC70
Composición:

- 1 Conjunto Cortador Ref. EBC70-1
- 5 Coronas Cortadoras de 9 mm Ref. EBC70-2
- 2 Punzones guía Ref. EBC70-3
- 1 Broca Ref. BC60 Ø 8 mm

96,26 €

BROCA SIERRA LIMA-RASPA

PARA TALADRAR Y CONTORNEAR EN MADERA, CHAPA METÁLICA Y PLÁSTICO



* Broca especial para carroceros.

Ø mm	L1 x L2 mm	BC80	BC81
		HSS €	TiN €
6	90 x 60	15,55	24,40
8	90 x 60	20,00	31,24

BROCA FRESA DE METAL DURO

Ref. BC91

MD

Utilizadas para Taladrar, Puntear, Fresar y Avellanar.



Ti

INC

Ni

INOX

PVC

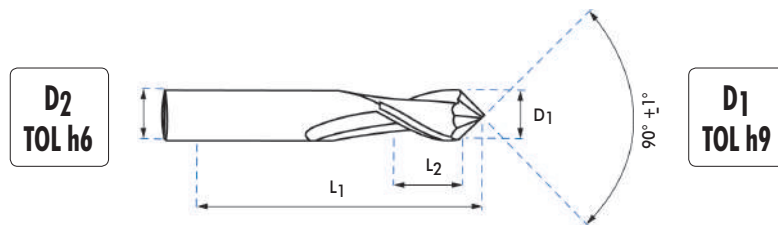

D1 mm	D2 mm	L1 x L2 mm	BC91 €
3	3	45 x 6	53,03
4	4	50 x 8	60,28
5	5	50 x 10	68,90
6	6	50 x 12	74,59
8	8	70 x 16	103,60
10	10	70 x 18	144,11
12	12	70 x 20	144,11
14	14	88 x 30	171,90
16	16	80 x 26	205,84
20	20	100 x 32	363,66

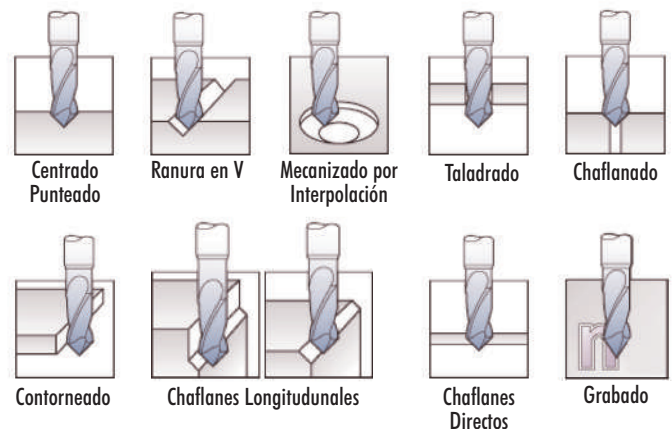

FLUOBROCAS PARA ROSCADO DE PAREDES FINAS

Con collar SIMPLE



Ref. FLUOB

Con collar CORTADOR



Ref. FLUOBP

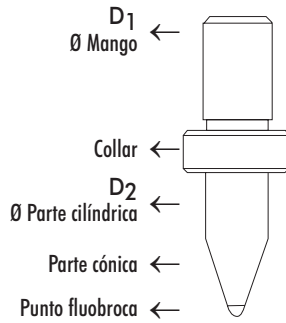

	e max. mm	D1 mm	D2 mm	R.P.M.	FLUOB		FLUOBP	
					€		€	
M3x0,50	1,7	6	2,7	3000	FLUOBM03	117,47	FLUOBPM03	164,46
M4x0,70	1,7	6	3,7	2600	FLUOBM04	121,74	FLUOBPM04	170,44
M5x0,80	2,0	6	4,5	2500	FLUOBM05	127,15	FLUOBPM05	184,73
M6x1,00	2,0	6	5,3	2400	FLUOBM06	135,53	FLUOBPM06	196,90
M8x1,25	2,4	8	7,3	2200	FLUOBM08	167,22	FLUOBPM08	242,95
M10x1,50	2,6	10	9,2	2000	FLUOBM10	189,50	FLUOBPM10	275,32
M12x1,75	3,0	12	10,9	1800	FLUOBM12	203,18	FLUOBPM12	279,18
M16x2,00	3,4	16	14,8	1200	FLUOBM16	280,24	FLUOBPM16	357,94
M20x2,50	3,8	18	18,7	800	FLUOBM20	395,58	FLUOBPM20	504,60

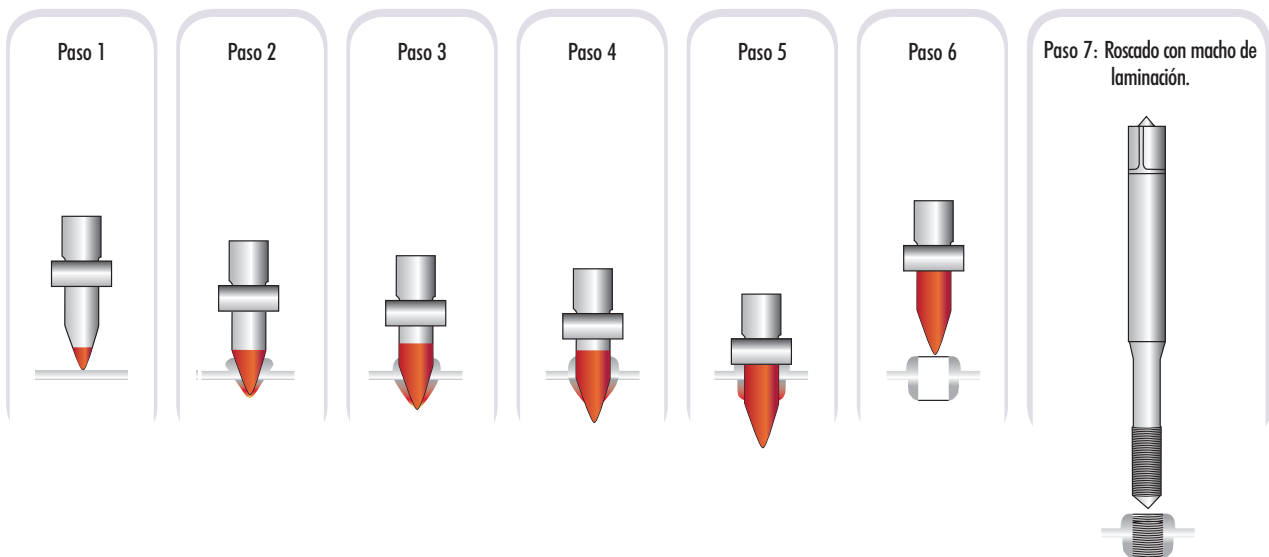
CUT MAGIC PASTY (250ml.y 750ml.)

		UNIDAD DE EMBALAJE	PASTY €
ACPU00250	0,250 l.	1 Lata	23,71
ACPU00750	0,750 l.	1 Lata	35,88



Ref. ACPU00250



Ref. ACPU00750

BROCAS BIDIAMETRALES HSS

MANGO CILÍNDRICO Y MANGO CÓNICO

Ref. BC26 **HSS** **DIN 8376** **180°**

ASIENTO ALLEN

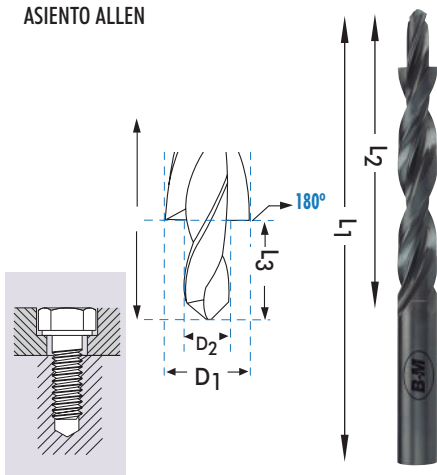

BC26

	D2 mm	D1 mm	L1 x L2 mm	L3 mm	€
M3	3,4	6	93 x 57	9	52,95
M4	4,5	8	117 x 75	11	55,53
M5	5,5	10	133 x 87	13	66,00
M6	6,6	11	142 x 94	15	74,58
M8	9,0	15	169 x 114	19	91,63
M10	11,0	18	191 x 130	23	182,09

Ref. BC24 **HSS** **DIN 8374** **90°**

ASIENTO CÓNICO
para tornillos DIN 7991

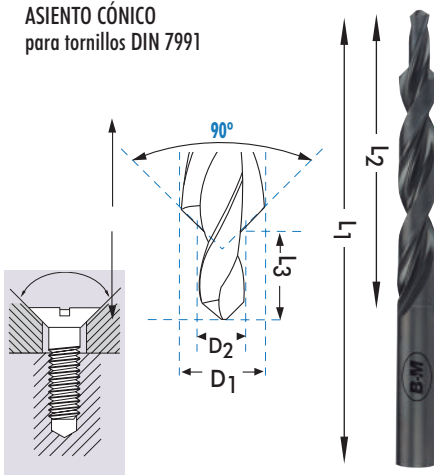

BC24

	D2 mm	D1 mm	L1 x L2 mm	L3 mm	€
M3	3,2	6,0	93 x 57	9	61,78
M4	4,3	8,0	117 x 75	11	64,80
M5	5,3	10,0	133 x 87	13	77,01
M6	6,4	11,5	142 x 94	15	87,97
M8	8,4	15,0	169 x 114	19	120,32
M10	10,5	19,0	198 x 135	23	185,79

Ref. BC28 **HSS** **DIN 8378** **90°**

Taladro previo al roscado

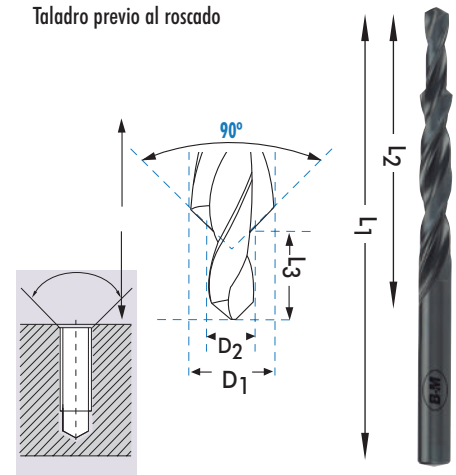

BC28

	D2 mm	D1 mm	L1 x L2 mm	L3 mm	€
M3	2,5	3,4	70 x 39	8,8	47,50
M4	3,3	4,5	80 x 47	11,8	51,10
M5	4,2	5,5	93 x 57	13,6	55,05
M6	5,0	6,6	101 x 63	16,5	62,63
M8	6,8	9,0	125 x 81	21,0	74,63
M10	8,5	11,0	142 x 94	25,5	87,06
M12	10,2	13,5	160 x 108	30,0	108,39

Ref. BC27 **HSS** **DIN 8377** **180°**

ASIENTO ALLEN

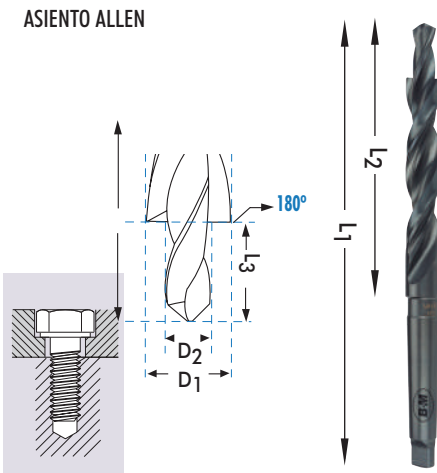

BC27

	D2 mm	D1 mm	L1 x L2 mm	L3 mm	CM	€
M6	6,6	11	175 x 94	15	1	132,69
M8	9,0	15	212x114	19	2	137,03
M10	11,0	18	228x130	23	2	154,50
M12	13,5	20	238x140	27	2	172,82
M14	15,5	24	281x160	31	3	245,07
M16	17,5	26	286x165	35	3	349,43
M18	20,0	30	296x175	39	3	390,75
M20	22,0	33	334x185	43	4	441,83

Ref. BC25 **HSS** **DIN 8375** **90°**

ASIENTO CÓNICO
para tornillos DIN 7991

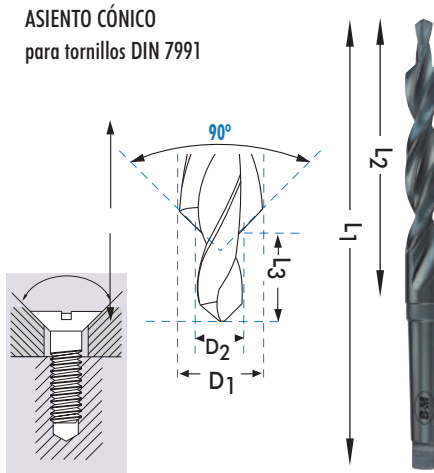

BC25

	D2 mm	D1 mm	L1 x L2 mm	L3 mm	CM	€
M5	5,5	11,0	175 x 94	13	1	132,55
M6	6,6	13,0	182x101	15	1	135,23
M8	9,0	17,2	228x130	19	2	161,16
M10	11,0	21,5	248x150	23	2	190,81

Ref. BC29 **HSS** **DIN 8379** **90°**

Taladro previo al roscado

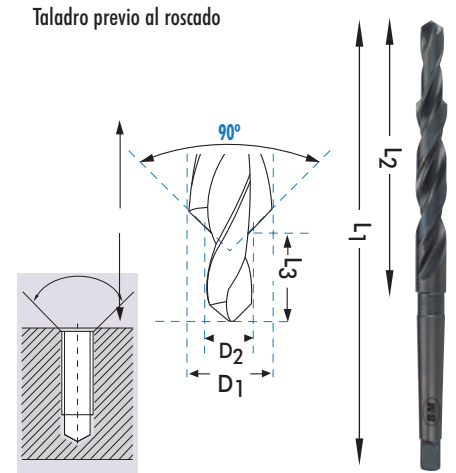

BC29

	D2 mm	D1 mm	L1 x L2 mm	L3 mm	CM	€
M8	6,8	9,0	162 x 81	21,0	1	121,58
M10	8,5	11,0	175 x 94	25,5	1	132,47
M12	10,2	13,5	189x108	30,0	1	156,47
M14	12,0	15,5	218x120	34,5	2	166,97
M16	14,0	17,5	228x130	38,5	2	180,20
M18	15,5	20,0	238x140	43,5	2	201,55
M20	17,5	22,0	248x150	47,5	2	243,69

BROCAS EXTRACORTAS ESCALONADAS

Brocas Metal

Rosa

Ref. BC36

HSSCo 5% **90°**

BC36

	D1 mm	D2 mm	D3 mm	L1 x L2 mm	L3 mm	€
M3	3,4	2,5	3,4	52 x 20	8	25,71
M4	4,5	3,3	4,5	58 x 24	11	26,93
M5	5,5	4,2	5,5	66 x 28	13	28,16
M6	6,6	5,0	6,6	70 x 31	16	30,61
M8	9,0	6,8	9,0	84 x 40	20	36,73
M10	11,0	8,5	11,0	95 x 47	24	48,36
M12	14,0	10,2	14,0	107 x 54	29	64,89
M14	16,0	12,0	16,0	115 x 56	32	165,28
M16	18,0	14,0	18,0	135 x 60	34	208,13

Ref. BCMD36

MD **90°** **TiAlN**

BCMD36

	D1 mm	D2 mm	D3 mm	L1 x L2 mm	L3 mm	€
M3	6,0	2,5	6,0	66 x 20	8,8	48,97
M4	6,0	3,3	6,0	66 x 24	11,4	57,13
M5	6,0	4,2	6,0	66 x 28	13,6	61,22
M6	8,0	5,0	8,0	79 x 31	16,5	71,42
M8	10,0	6,8	10,0	89 x 40	21,0	97,94
M10	12,0	8,5	12,0	102 x 47	25,5	132,64
M12	14,0	10,2	14,0	107 x 54	30,0	183,65

Ref. BC74

HSSCo 5% **180°**

BC74

	D1 mm	D2 mm	D3 mm	L1 x L2 mm	L3 mm	€
M2	4,3	2,4	4,3	45 x 12	6	17,76
M3	6,0	3,4	6,0	45 x 18	9	18,06
M4	8,0	4,5	8,0	50 x 22	11	21,43
M5	10,0	5,5	10,0	55 x 26	13	23,88
M6	11,0	6,6	11,0	63 x 30	15	30,00
M8	15,0	9,0	12,5	100 x 34	19	56,32
M10	18,0	11,0	12,5	110 x 42	23	82,03
M12	20,0	14,0	12,5	110 x 34	28	107,74
M14	24,0	16,0	12,5	120 x 42	34	217,93

Ref. BC34

HSSCo 5% **90°**

BC34

	D1 mm	D2 mm	D3 mm	L1 x L2 mm	L3 mm	€
M2	4,6	2,2	4,6	45 x 12	6	17,76
M3	6,5	3,2	6,5	45 x 18	9	18,06
M4	8,6	4,3	8,6	50 x 26	11	21,43
M5	10,4	5,3	10,4	55 x 30	13	23,88
M6	12,4	6,4	12,4	63 x 34	15	30,00
M8	16,4	8,4	12,5	100 x 42	19	56,32
M10	20,4	10,5	12,5	110 x 34	23	82,03
M12	25,0	13,0	12,5	120 x 42	28	217,93

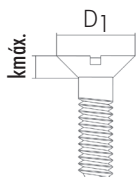

DIN 7991

	M2	M2.5	M3	M4	M5	M6	M8	M10	M12	M14	M16	M18	M20
Kmáx.	1,2	1,5	1,7	2,3	2,8	3,3	4,4	5,5	6,5	7	7,5	8	8,5
D1	4	5	6	8	10	12	16	20	24	27	30	33	36

BROCAS HELICOIDALES CON MANGO CÓNICO DIN 345

DIN 345



Para taladrar agujeros superiores a Ø25mm se recomienda realizar un agujero previo igual a un tercio del diámetro final a taladrar.
Ejemplo: si va a usar una broca de Ø30mm, realice un agujero previo de Ø10mm.

		BC11	BC22	BC32	BC21	BC13																
		Ø mm	L1 x L2 mm	CM	€	€	€	€	€	€												
		10,75	175 x 94	1	32,18																	
		11,00	175 x 94	1	27,79	84,17				41,65	79,23											
		11,25	175 x 94	1	33,59																	
		11,50	175 x 94	1	29,22	87,65				42,75	79,23											
		11,75	175 x 94	1	33,60																	
		12,00	182 x 101	1	29,38	90,41				31,61	82,72											
		12,25	182 x 101	1	37,41																	
		12,50	182 x 101	1	31,44	94,64				44,09	82,89											
		12,75	182 x 101	1	37,42																	
		13,00	182 x 101	1	32,78	92,61	71,58			45,02	94,35											
		13,25	189 x 101	1	41,41																	
		13,50	189 x 101	1	34,59	121,31	86,51			46,46	94,09											
		13,75	189 x 101	1	41,41																	
		14,00	189 x 108	1	34,62	119,07	82,24			37,32	102,52											
		14,25	212 x 114	2	44,85																	
		14,50	212 x 114	2	38,97	131,76	100,92			62,33	102,50											
		14,75	212 x 114	2	44,84																	
		15,00	212 x 114	2	38,97	121,44	95,93			62,33	115,99											
		15,25	218 x 120	2	46,13																	
		15,50	218 x 120	2	40,11	134,27	99,00			64,16	123,52											
		15,75	218 x 120	2	46,13	165,62	123,74															
		16,00	218 x 120	2	40,33	127,77	99,00			42,32	123,46											
		16,25	223 x 125	2	52,15																	
		16,50	223 x 125	2	45,58	135,67	105,07			65,46	123,85											
		16,75	223 x 125	2	52,15																	
		17,00	223 x 125	2	45,57	133,63	105,07			65,12	131,21											
		17,25	228 x 130	2	57,75																	
		17,50	228 x 130	2	50,40	141,70	111,15			70,15	131,04											
		17,75	228 x 130	2	57,75	193,23	148,48															
		18,00	228 x 130	2	48,41	139,00	118,80			48,30	141,82											
		18,25	233 x 135	2	63,49																	
		18,50	233 x 135	2	55,47	152,53	123,36			71,87	165,76											
		18,75	233 x 135	2	63,91																	
		19,00	233 x 135	2	55,66	149,18	123,36			60,49	165,52											
		19,25	238 x 140	2	69,13																	
		19,50	238 x 140	2	60,19	172,39	129,43			77,01	185,89											
		19,75	238 x 140	2	69,60																	
		20,00	238 x 140	2	60,22	166,65	129,43			63,62	186,33											
		20,25	243 x 145	2	72,01																	
		20,50	243 x 145	2	62,41	191,93	150,77			78,17	189,35											
		20,75	243 x 145	2	72,01																	
		21,00	243 x 145	2	62,41	194,09	150,77			77,82	189,35											
		21,25	248 x 150	2	79,46																	
		21,50	248 x 150	2	68,82	218,66	164,47			82,33	206,44											
		21,75	248 x 150	2	79,46	282,74	205,60															
		22,00	248 x 150	2	68,95	197,20	164,47			74,09	206,44											
		22,00*	265 x 150	3	93,73																	
		22,25	248 x 150	2	86,97																	
		22,50	253 x 155	2	75,45	244,57	173,61			89,65	206,77											
		22,75	253 x 155	2	86,97																	
		23,00	253 x 155	2	75,29	229,73	188,83			89,00	224,26											
		23,25	276 x 155	3	95,92																	
		23,50	276 x 155	3	83,55	244,07	227,65			107,24	224,11											
		23,75	281 x 160	3	96,03																	
		24,00	281 x 160	3	83,37	247,22	210,17			85,59	246,51											

Cono reforzado, DIN 346, bajo demanda

Brocas Metal

Rosa Gris

BROCAS HELICOIDALES CON MANGO CÓNICO DIN 345

Brocas Metal

Gris

Rosa

DIN 345



Para taladrar agujeros superiores a Ø25mm se recomienda realizar un agujero previo igual a un tercio del diámetro final a taladrar.
Ejemplo: si va a usar una broca de Ø30mm, realice un agujero previo de Ø10mm.

			BC11	BC22	BC32	BC21	BC13
Ø mm	L1 x L2 mm	CM	€	€	€	€	€
31,00	301x180	3	150,78	363,86		171,51	503,06*
31,25	301x180	3	183,48				
31,50	301x180	3	158,55	558,93			
31,75	306x185	3	183,48	440,25	498,74		
32,00	334x185	4	158,82	420,93	398,98	179,46	503,01*
32,00	334x185	3	295,75				
32,25	334x185	4	214,14				
32,50	334x185	4	182,44				
32,75	334x185	4	214,14				
33,00	334x185	4	181,35	481,23		195,32	619,91*
33,25	334x185	4	223,68				
33,50	334x185	4	197,84				
33,75	339x190	4	224,90				
34,00	339x190	4	197,24	542,22		277,56	620,95*
34,25	339x190	4	245,77				
34,50	339x190	4	215,43				
34,75	339x190	4	245,77	589,51	683,35		
35,00	339x190	4	216,50	569,76	546,66	306,03	620,78*
35,25	339x190	4	263,41				
35,50	339x190	4	231,11				
35,75	344x195	4	270,47				
36,00	344x195	4	231,68	612,13		317,64	997,25*
36,25	344x195	4	284,28				
36,50	344x195	4	245,03				
36,75	344x195	4	284,25				
37,00	344x195	4	244,70	572,13		326,90	1.077,11*
37,25	344x195	4	302,97				
37,50	344x195	4	256,41				
37,75	344x195	4	302,97				
38,00	349x200	4	257,00	660,28		336,24	1.127,74*
38,25	349x200	4	320,17				
38,50	349x200	4	273,48				
38,75	349x200	4	320,17				
39,00	349x200	4	273,70	675,64		348,83	1.191,07*
39,25	349x200	4	322,04				
39,50	349x200	4	289,87				
39,75	349x200	4	322,04				
40,00	349x200	4	289,50	708,02		360,16	1.228,67*
40,50	354x205	4	303,47				
41,00	354x205	4	303,85	744,27			
41,50	354x205	4	322,97				
42,00	354x205	4	322,31	779,30			
42,50	354x205	4	338,72				
43,00	359x210	4	338,73	817,14			
43,50	359x210	4	354,65				
44,00	359x210	4	354,87	848,49			
44,50	359x210	4	371,13				
45,00	359x210	4	371,42	887,33			
45,50	364x215	4	385,92				
46,00	364x215	4	384,30	924,17			
46,50	364x215	4	401,68				
47,00	364x215	4	401,48	958,76			
47,50	364x215	4	415,16				
48,00	369x220	4	414,87	998,95			
48,50	369x220	4	431,63				

Cono reforzado, DIN 346, bajo demanda

*Hasta fin de existencias

BROCA HELICOIDAL CON MANGO CÓNICO DIN 345

Ref. BC11

DIN 345

HSS



Ref. BC11350MC

BC11			
Ø mm	L1 x L2 mm	CM	€
49,00	369x220	4	429,82
49,50	369x220	4	443,34
50,00	369x220	4	448,10
50,50	369x220	4	641,64
51,00	412x225	5	525,45
51,50	412x225	5	704,27
52,00	412x225	5	561,57
52,50	412x225	5	721,41
53,00	412x225	5	601,44
53,50	412x225	5	754,66
54,00	417x230	5	661,85
54,50	417x230	5	747,09
55,00	417x230	5	655,20
56,00	417x230	5	737,23
57,00	422x235	5	783,20
58,00	422x235	5	789,88
59,00	422x235	5	813,60
60,00	422x235	5	770,18
61,00	427x240	5	903,38
62,00	427x240	5	940,89
63,00	427x240	5	995,03
64,00	432x245	5	1.049,83
65,00	432x245	5	1.005,22
66,00	432x245	5	1.133,34
67,00	432x245	5	1.169,88
68,00	437x250	5	1.200,22
69,00	437x250	5	1.237,54
70,00	437x250	5	1.117,51
71,00	437x250	5	1.290,20
72,00	442x255	5	1.316,92
73,00	442x255	5	1.351,39
74,00	442x255	5	1.390,94
75,00	442x255	5	1.310,22
76,00	447x260	5	1.542,79
77,00	514x260	6	1.655,60
78,00	514x260	6	1.687,95
79,00	514x260	6	1.721,96
80,00	514x260	6	1.816,36
81,00	519x265	6	2.000,45
82,00	519x265	6	2.050,44
83,00	519x265	6	2.089,77
84,00	519x265	6	2.134,13
85,00	519x265	6	2.186,85
86,00	524x270	6	2.234,59
87,00	524x270	6	2.282,05
88,00	524x270	6	2.340,70
89,00	524x270	6	2.386,01
90,00	524x270	6	2.454,29
91,00	529x275	6	2.588,57
92,00	529x275	6	2.603,49
93,00	529x275	6	2.696,33
94,00	529x275	6	2.751,12
95,00	529x275	6	2.807,65
96,00	534x280	6	2.900,14
97,00	534x280	6	2.924,47
98,00	534x280	6	2.989,71
99,00	534x280	6	3.043,77
100,00	534x280	6	3.101,84

EXPOSITOR 25 BROCAS MANGO CÓNICO

BC11350MC

Cono Morse n° 1	14									DIN 345
	1	14,50	15	15,50	16	16,50	17	17,50	18	18,50
n° 2		1	1	1	1	1	1	1	1	1
		19	19,5	20	20,5	21	21,5	22	22,5	23
n° 3		1	1	1	1	1	1	1	1	1

Dimensiones:
ancho 260 x fondo 200 x alto 280 mm

1.793,20 €

EXPOSITORES VACÍOS PARA BROCAS CON MANGO CÓNICO



REFERENCIA	D9351MC	D0350MC	D9352MC	D9353MC
Nº BROCAS	10	25	1	1
DIMENSIONES	260 x 105 x 80 mm	260 x 280 x 200 mm	Reductor CONO MORSE 1	Reductor CONO MORSE 2
P.V.P. €	118,63	398,08	20,36	20,36

*El precio del expositor vacío incluye los reductores necesarios para mangos CONO MORSE 1 y CONO MORSE 2

RECARGOS POR REBAJAR MANGOS CÓNICOS



n° 2-1	n° 2-0
n° 3-2	n° 3-1
n° 4-3	n° 4-2
n° 5-4	n° 5-3
n° 6-5	n° 6-4

€ NETO 50,76 76,13

BROCA MANGO CÓNICO PARA TALADRADO DE MATERIALES DUROS Y RESISTENTES

Brocas Metal

Rosa

Ref. BC73

HSSCo
8%

OX

HARDOX
450

BC73					
	D1 mm	L1 mm	L2 mm	CM	€
BC731000	10,00	175	76	2	49,73
BC731020	10,20	175	76	2	49,73
BC731100	11,00	175	76	2	49,73
BC731200	12,00	179	81	2	54,46
BC731250	12,50	179	81	2	54,46
BC731300	13,00	179	81	2	54,46
BC731400	14,00	184	86	2	57,98
BC731450	14,50	187	89	2	58,74
BC731500	15,00	187	89	2	59,12
BC731550	15,50	187	89	2	67,15
BC731600	16,00	187	89	2	70,34
BC731650	16,50	190	92	2	73,59
BC731700	17,00	190	92	2	74,98
BC731800	18,00	190	92	2	76,11
BC731850	18,50	213	95	3	84,83
BC731900	19,00	213	95	3	86,48
BC732000	20,00	213	95	3	91,94
BC732100	21,00	219	102	3	100,13
BC732200	22,00	222	105	3	115,11
BC732400	24,00	222	105	3	124,01
BC732500	25,00	225	108	3	146,95
BC732600	26,00	270	124	4	174,12
BC732700	27,00	270	124	4	187,26
BC732800	28,00	270	124	4	194,44
BC733000	30,00	270	124	4	216,28
BC733200	32,00	280	133	4	251,72
BC733500	35,00	292	136	4	314,52
BC733600	36,00	292	146	4	330,79
BC734000	40,00	298	152	4	415,85
BC734500	45,00	298	152	4	565,57
BC735000	50,00	356	152	5	664,42
BC735500	55,00	360	156	5	789,36
BC736000	60,00	360	156	5	963,36

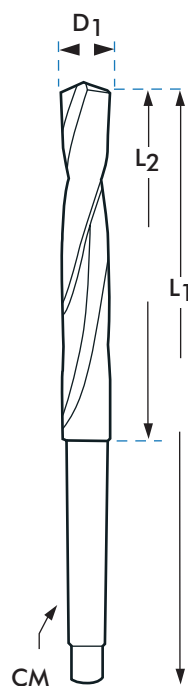

Broca especial para HARDOX 450



Para taladrar agujeros superiores a Ø25mm se recomienda realizar un agujero previo igual a un tercio del diámetro final a taladrar.

Ejemplo; si va a usar una broca de Ø30mm, realice un agujero previo de Ø10mm.

BROCA MANGO CÓNICO PARA TALADRADO DE MATERIALES DUROS Y RESISTENTES

Ref. BC22..FT

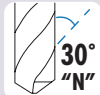
DIN
345
HSSCo
5%
TiN

120
Kg/mm²
HARDOX
450

BC22...					
	D1 mm	L1 mm	L2 mm	CM	€
BC221600FT	16,00	218	120	2	91,23
BC221800FT	18,00	228	130	2	99,25
BC222000FT	20,00	238	140	2	118,98
BC222200FT	22,00	248	150	2	140,80
BC222400FT	24,00	281	160	3	176,52
BC222500FT	25,00	281	160	3	184,93
BC222600FT	26,00	286	165	3	218,60
BC222800FT	28,00	291	170	3	268,79
BC223000FT	30,00	296	175	3	265,61
BC223200FT	32,00	334	185	4	300,54
BC223400FT	34,00	339	190	4	387,15
BC223600FT	36,00	344	195	4	437,06



- La mejor solución para taladrado de orificios de gran diámetro en materiales de alta dureza
- Afilado especial materiales muy duros, con corte corregido y matado el corte lateral del filo

* Esta broca se ha usado históricamente para taladrado de railes de ferrocarril.

Broca especial para HARDOX 450



BROCAS HELICOIDALES CON MANGO CÓNICO SERIE LARGA

**DIN
341**

Ref. BC12



Ref. BC56



			BC12	BC56						BC12	BC56						BC12	BC56		
MATERIAL			HSS	HSSCo 5%	AFILADO			Ø mm	L1 x L2	CM	€	€	AFILADO			Ø mm	L1 x L2	CM	€	€
ÁNGULO PUNTA			118°	135°	HÉLICE								HÉLICE							
ACABADO			OX	OX	APLICACIÓN								APLICACIÓN							
Ø mm	L1 x L2	CM	€	€	70 Kg/mm ²	120 Kg/mm ²	Ø mm	L1 x L2	CM	€	€	70 Kg/mm ²	120 Kg/mm ²	Ø mm	L1 x L2	CM	€	€	70 Kg/mm ²	120 Kg/mm ²
5,00	155x74	1	20,61				14,00	223x142	1	39,06	98,22			27,00	343x222	3	130,68	316,51		
5,50	161x80	1	27,64				14,25	245x147	2	65,59				27,50	343x222	3	168,41			
6,00	161x80	1	21,92				14,50	245x147	2	49,15				28,00	343x222	3	149,16	325,83		
6,50	167x86	1	22,39				14,75	245x147	2	65,59				28,50	351x230	3	199,87			
7,00	174x93	1	23,77				15,00	245x147	2	49,15	114,05			29,00	351x230	3	163,34	353,78		
7,50	174x93	1	25,00				15,25	251x153	2	64,94				29,50	351x230	3	200,05			
8,00	181x100	1	25,43				15,50	251x153	2	48,23	118,69			30,00	351x230	3	167,52	372,38		
8,50	181x100	1	25,43				15,75	251x153	2	67,35				30,50	360x239	3	228,73			
9,00	188x107	1	28,06				16,00	251x153	2	50,02	118,69			31,00	360x239	3	211,55	418,93		
9,50	188x107	1	30,69				16,25	257x159	2	73,26				31,50	360x239	3	245,36			
10,00	197x116	1	31,61	66,32			16,50	257x159	2	54,38	125,70			32,00	397x248	4	212,39	465,49		
10,25	197x116	1	37,82				16,75	257x159	2	73,26				32,50	397x248	4	268,88			
10,50	197x116	1	32,88				17,00	257x159	2	54,38	125,70			33,00	397x248	4	226,33			
10,75	197x116	1	48,20				17,25	263x165	2	71,69				33,50	397x248	4	265,48			
11,00	206x125	1	31,61	72,62			17,50	263x165	2	57,79	132,67			34,00	406x257	4	275,49			
11,25	206x125	1	48,20				17,75	263x165	2	81,51				34,50	406x257	4	291,70			
11,50	206x125	1	31,61				18,00	263x165	2	60,51	141,98			35,00	406x257	4	277,15			
11,75	206x125	1	43,50				18,25	269x171	2	81,84				35,50	406x257	4	291,70			
12,00	215x134	1	33,80	81,67			18,50	269x171	2	65,68	147,78			36,00	416x267	4	318,90			
12,25	215x134	1	43,50				18,75	269x171	2	84,47				36,50	416x267	4	403,57			
12,50	215x134	1	34,67				19,00	269x171	2	63,86	147,78			37,00	416x267	4	343,48			
12,75	215x134	1	46,67				19,25	275x177	2	88,64				37,50	416x267	4	399,92			
13,00	215x134	1	34,67	85,43			19,50	275x177	2	71,78	154,07			38,00	426x277	4	359,59			
13,25	223x142	1	48,66				19,75	275x177	2	89,73				38,50	426x277	4	455,85			
13,50	223x142	1	37,79				20,00	275x177	2	68,47	154,07			39,00	426x277	4	373,60			
13,75	223x142	1	52,56				20,50	282x184	2	83,03	179,21			39,50	426x277	4	455,85			
							21,00	282x184	2	78,56	179,21			40,00	426x277	4	404,06			
							21,50	289x191	2	94,77	195,50			41,00	436x287	4	516,65			
							22,00	289x191	2	89,43	195,50			42,00	436x287	4	538,89			
							22,50	296x198	2	97,72	207,13			43,00	447x298	4	573,52			
							23,00	296x198	2	89,47	223,44			44,00	447x298	4	582,26			
							23,50	319x198	3	113,78	230,40			45,00	447x298	4	613,67			
							24,00	327x206	3	114,85	251,36			46,00	459x310	4	645,71			
							24,50	327x206	3	121,99	260,67			47,00	459x310	4	679,58			
							25,00	327x206	3	114,83	244,39			48,00	470x321	4	710,35			
							25,50	335x214	3	138,48				49,00	470x321	4	733,56			
							26,00	335x214	3	121,07	288,60			50,00	470x321	4	759,47			
							26,50	335x214	3	142,85				55,00	505x310	5	993,07			

* Consultar otras longitudes especiales disponibles bajo demanda.

BROCAS HELICOIDALES CON MANGO CÓNICO SERIE EXTRALARGA
**DIN
1870
I/II**

Ref. BC14



Ref. BC41



			BC14	BC41											
			HSS	HSSCo 5%											
APLICACIÓN	Ø mm	L1 x L2	CM	€	€	Ø mm	L1 x L2	CM	€	€	Ø mm	L1 x L2	CM	€	€
8,00	265x165	1	70,94			29,00	460x305	3	394,56	922,47					
8,00	330x210	1	88,42			29,00	580x385	3	565,72	1.252,16					
8,50	265x165	1	77,90			29,50	460x305	3	408,50	1.056,07					
8,50	330x210	1	90,39			29,50	580x385	3	570,39	1.457,34					
9,00	275x175	1	80,19			30,00	460x305	3	408,50	965,09					
9,00	345x220	1	101,92			30,00	580x385	3	570,39	1.301,70					
9,50	275x175	1	85,81			30,50	480x320	4		1.180,73					
9,50	345x220	1	103,03			30,50	610x410	4							
10,00	285x185	1	88,16			31,00	480x320	4	457,89	1.221,42					
10,00	360x235	1	108,74			31,00	610x410	4	608,11						
10,50	285x185	1	93,63			32,00	505x320	4	478,77						
10,50	360x235	1	112,07			32,00	635x410	4	638,06						
11,00	300x195	1	97,74			33,00	505x320	4	521,70						
11,00	375x250	1	116,24			33,00	635x410	4	706,37						
11,50	300x195	1	107,04			34,00	530x340	4	565,69						
11,50	375x250	1	133,69			34,00	665x430	4	732,95						
12,00	310x205	1	109,55			35,00	530x340	4	582,66						
12,00	395x260	1	136,50			35,00	665x430	4	796,50						
12,50	310x205	1	116,58			36,00	530x340	4	628,59						
12,50	395x260	1	152,34			36,00	665x430	4	836,37						
13,00	310x205	1	116,58	260,72		37,00	530x340	4	644,49						
13,00	395x260	1	152,34			37,00	665x430	4	929,28						
13,50	325x220	1	127,63			38,00	555x360	4	703,03						
13,50	410x275	1	156,46			38,00	695x460	4	984,06						
14,00	325x220	1	127,67	248,86		39,00	555x360	4	732,70						
14,00	410x275	1	156,46	348,65		39,00	695x460	4	1.031,01						
14,50	340x220	2	139,82	272,23		40,00	555x360	4	772,40						
14,50	425x275	2	170,39	382,28		40,00	695x460	4	983,43						
15,00	340x220	2	139,82	261,51		41,00	555x360	4	869,09						
15,00	425x275	2	170,39	371,30		41,00	695x460	4	1.117,78						
15,50	355x230	2	156,73	304,13		42,00	555x360	4	897,72						
15,50	445x295	2	187,94	409,78		42,00	695x460	4	1.193,46						
16,00	355x230	2	156,73	288,83		43,00	585x385	4	936,17						
16,00	445x295	2	187,94	399,37		43,00	735x490	4	1.217,75						
16,50	355x230	2	168,75	304,13		44,00	585x385	4	980,37						
16,50	445x295	2	203,08	414,48		44,00	735x490	4	1.260,55						
						45,00	585x385	4	1.009,84						
						45,00	735x490	4	1.319,26						
						46,00	585x385	4	1.040,71						
						46,00	735x490	4	1.378,24						
						47,00	585x385	4	1.127,42						
						47,00	735x490	4	1.445,89						
						48,00	605x405	4	1.127,90						
						48,00	765x510	4	1.530,00						
						49,00	605x405	4	1.162,25						
						49,00	765x510	4	1.588,24						
						50,00	605x405	4	1.196,45						
						50,00	765x510	4	1.629,76						

BROCA CON MANGO CÓNICO HSS CON REFRIGERACIÓN INTERIOR

Ref. BC87

≤10xD

DIN
341

HSS



OX



AFILADO ESPECIAL 170°
CON PUNTA PILOTO
CENTRADO PRECISO

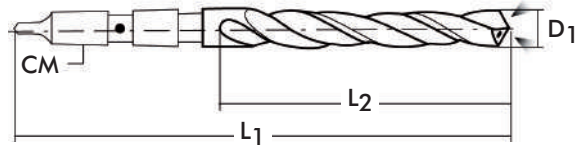

BC87					
	D1 mm	L1 mm	L2 mm	CM	€
BC871000	10,0	214	116	2	407,52
BC871050	10,5	214	116	2	413,11
BC871100	11,0	223	125	2	413,11
BC871150	11,5	223	125	2	422,15
BC871200	12,0	232	134	2	422,15
BC871250	12,5	232	134	2	422,15
BC871300	13,0	232	134	2	422,15
BC871350	13,5	240	142	2	422,15
BC871400	14,0	240	142	2	422,15
BC871450	14,5	245	147	2	436,54
BC871500	15,0	245	147	2	436,54
BC871550	15,5	251	153	2	451,21
BC871600	16,0	251	153	2	451,21
BC871650	16,5	257	159	2	451,21
BC871700	17,0	257	159	2	451,21
BC871750	17,5	263	165	2	479,96
BC871800	18,0	263	165	2	479,96
BC871850	18,5	292	171	3	494,72
BC871900	19,0	292	171	3	494,72
BC871950	19,5	298	177	3	523,74
BC872000	20,0	298	177	3	523,74
BC872050	20,5	305	184	3	553,04
BC872100	21,0	305	184	3	553,04
BC872150	21,5	312	191	3	587,66
BC872200	22,0	312	191	3	587,66
BC872250	22,5	319	198	3	582,05
BC872300	23,0	319	198	3	582,05

BC87					
	D1 mm	L1 mm	L2 mm	CM	€
BC872350	23,5	319	198	3	582,05
BC872400	24,0	327	206	3	582,05
BC872450	24,5	327	206	3	594,09
BC872500	25,0	327	206	3	594,09
BC872550	25,5	335	214	3	655,01
BC872600	26,0	335	214	3	655,01
BC872650	26,5	335	214	3	684,03
BC872700	27,0	371	222	4	684,03
BC872750	27,5	371	222	4	750,74
BC872800	28,0	371	222	4	750,74
BC872850	28,5	379	230	4	800,65
BC872900	29,0	379	230	4	800,65
BC872950	29,5	379	230	4	855,77
BC873000	30,0	379	230	4	855,77
BC873050	30,5	379	230	4	1.018,71
BC873100	31,0	388	239	4	1.018,71
BC873150	31,5	388	239	4	1.018,71
BC873200	32,0	397	248	4	1.018,71
BC873300	33,0	397	248	4	1.190,33
BC873400	34,0	406	257	4	1.190,33
BC873500	35,0	406	257	4	1.338,66
BC873600	36,0	406	257	4	1.338,66
BC873700	37,0	406	257	4	1.513,30
BC873800	38,0	426	277	4	1.513,30
BC873900	39,0	426	277	4	1.688,09
BC874000	40,0	426	277	4	1.688,09

BROCAS EN ESTUCHES DE METAL Y PLÁSTICO
**DIN
338**
HSS

(Brocas Ref. BC2)

REFERENCIA	D0010	D0011	P6010	P6011
Nº BROCAS	19	25	19	25
CALIDAD	HSS	HSS	HSS	HSS
CONTENIDO	Ø 1-10 x 0,50 mm	Ø 1-13 x 0,50 mm	Ø 1-10 x 0,50 mm	Ø 1-13 x 0,50 mm
P.V.P. €	55,17	114,78	55,17	114,78

Plus

(Brocas Ref. BC02)

REFERENCIA	DP010	DP011	PP6010	PP6011
Nº BROCAS	19	25	19	25
CALIDAD	<i>Plus</i>	<i>Plus</i>	<i>Plus</i>	<i>Plus</i>
CONTENIDO	Ø 1-10 x 0,50 mm	Ø 1-13 x 0,50 mm	Ø 1-10 x 0,50 mm	Ø 1-13 x 0,50 mm
P.V.P. €	62,37	129,03	62,37	129,03

**HSSCo
5%**

(Brocas Ref. BC5)

REFERENCIA	DC010	DC011	PC6010	PC6011
Nº BROCAS	19	25	19	25
CALIDAD	HSSCo	HSSCo	HSSCo	HSSCo
CONTENIDO	Ø 1-10 x 0,50 mm	Ø 1-13 x 0,50 mm	Ø 1-10 x 0,50 mm	Ø 1-13 x 0,50 mm
P.V.P. €	92,19	216,21	92,19	216,21

HSS
TiN

(Brocas Ref. BC18)

REFERENCIA	DT010	DT011	PT6010	PT6011
Nº BROCAS	19	25	19	25
CALIDAD	HSS+TiN	HSS+TiN	HSS+TiN	HSS+TiN
CONTENIDO	Ø 1-10 x 0,50 mm	Ø 1-13 x 0,50 mm	Ø 1-10 x 0,50 mm	Ø 1-13 x 0,50 mm
P.V.P. €	81,44	178,12	81,44	178,12

BROCAS EN ESTUCHES METÁLICOS (cuartos y décimas)

Brocas Metal

Rosa Gris

DIN
338

HSS

(Brocas Ref. BC2)



REFERENCIA	AD001	AD002	D0014	D0015
Nº BROCAS	37	49	50	41
CALIDAD	HSS	HSS	HSS	HSS
CONTENIDO	Ø 1-10 x 0,25 mm	Ø 1-13 x 0,25 mm	Ø 1-5,90 x 0,10 mm	Ø 6-10 x 0,10 mm
P.V.P. €	150,31	269,77	102,40	266,57

Plus

(Brocas Ref. BC02)



ESTE ESTUCHE SE SUMINISTRA
BAJO DEMANDA

ESTE ESTUCHE SE SUMINISTRA
BAJO DEMANDA

REFERENCIA	ADP01	ADP02		
Nº BROCAS	37	49	50	41
CALIDAD	Plus	Plus	Plus	Plus
CONTENIDO	Ø 1-10 x 0,25 mm	Ø 1-13 x 0,25 mm	Ø 1-5,90 x 0,10 mm	Ø 6-10 x 0,10 mm
P.V.P. €	180,10	320,41		

HSSCo
5%

(Brocas Ref. BC5)



REFERENCIA	ADC01	ADC02	DC014	DC015
Nº BROCAS	37	49	50	41
CALIDAD	HSSCo	HSSCo	HSSCo	HSSCo
CONTENIDO	Ø 1-10 x 0,25 mm	Ø 1-13 x 0,25 mm	Ø 1-5,90 x 0,10 mm	Ø 6-10 x 0,10 mm
P.V.P. €	217,36	486,48	160,17	394,88

HSS

TiN

(Brocas Ref. BC18)



ESTE ESTUCHE SE SUMINISTRA
BAJO DEMANDA

ESTE ESTUCHE SE SUMINISTRA
BAJO DEMANDA

REFERENCIA	ADT01	ADT02		
Nº BROCAS	37	49	50	41
CALIDAD	HSS+TiN	HSS+TiN	HSS+TiN	HSS+TiN
CONTENIDO	Ø 1-10 x 0,25 mm	Ø 1-13 x 0,25 mm	Ø 1-5,90 x 0,10 mm	Ø 6-10 x 0,10 mm
P.V.P. €	185,60	379,16		

BROCAS EN ESTUCHES METÁLICOS (previos y décimas)

Brocas Metal

Gris
Rosa

DIN 338 **HSS**



(Brocas Ref. BC2)

REFERENCIA	D0022	D0017	D0035	D0007
Nº BROCAS	81	23	29	10
CALIDAD	HSS	HSS	HSS	HSS
CONTENIDO	Ø 2-10 x 0,10 mm	Ø 1-10 x 0,50 + Ø previos*	Ø 1-13 x 0,50 + Ø previos*	Ø 1-10 x 1 mm
P.V.P. €	470,27	105,16	173,82	44,90

Plus

ESTE ESTUCHE SE SUMINISTRA
BAJO DEMANDA



(Brocas Ref. BC02)

REFERENCIA		DP017	DP035	DP007
Nº BROCAS	81	23	29	10
CALIDAD	<i>Plus</i>	<i>Plus</i>	<i>Plus</i>	<i>Plus</i>
CONTENIDO	Ø 2-10 x 0,10 mm	Ø 1-10 x 0,50 + Ø previos*	Ø 1-13 x 0,50 + Ø previos*	Ø 1-10 x 1 mm
P.V.P. €		105,32	181,16	58,92

HSSCo
5%

(Brocas Ref. BC5)



REFERENCIA	DC022	DC017	DC035	DC007
Nº BROCAS	81	23	29	10
CALIDAD	HSSCo	HSSCo	HSSCo	HSSCo
CONTENIDO	Ø 2-10 x 0,10 mm	Ø 1-10 x 0,50 + Ø previos*	Ø 1-13 x 0,50 + Ø previos*	Ø 1-10 x 1 mm
P.V.P. €	642,55	147,59	282,74	76,71

HSS **TiN**

ESTE ESTUCHE SE SUMINISTRA
BAJO DEMANDA

ESTE ESTUCHE SE SUMINISTRA
BAJO DEMANDA

ESTE ESTUCHE SE SUMINISTRA
BAJO DEMANDA



(Brocas Ref. BC18)

REFERENCIA				DT007
Nº BROCAS	81	23	29	10
CALIDAD	HSS+TiN	HSS+TiN	HSS+TiN	HSS+TiN
CONTENIDO	Ø 2-10 x 0,10 mm	Ø 1-10 x 0,50 + Ø previos*	Ø 1-13 x 0,50 + Ø previos*	Ø 1-10 x 1 mm
P.V.P. €				63,71

* Previos: de M3 a M12 (Ø3,30 - Ø4,20 - Ø6,80 - Ø10,20)

BROCAS EN ESTUCHES DE METAL Y PLÁSTICO (Composiciones adicionales)

Brocas Metal

Rosa Gris

DIN 338 **HSS**

BRILLANTE



HSSCo 8%



(Brocas Ref. BC82)

REFERENCIA	D8210
Nº BROCAS	19
CALIDAD	HSS
CONTENIDO	Ø 1-10 x 0,50 mm
P.V.P. €	55,17

REFERENCIA	D8211
Nº BROCAS	25
CALIDAD	HSS
CONTENIDO	Ø 1-13 x 0,50 mm
P.V.P. €	114,78

(Brocas Ref. BC58)

REFERENCIA	DC810
Nº BROCAS	19
CALIDAD	HSSCo 8%
CONTENIDO	Ø 1-10 x 0,50 mm
P.V.P. €	133,39

REFERENCIA	DC811
Nº BROCAS	25
CALIDAD	HSSCo 8%
CONTENIDO	Ø 1-13 x 0,50 mm
P.V.P. €	314,71

DIN 338 **HSSCo 5%**

OX DORADO



(Brocas Ref. BC95)

REFERENCIA	DC9510
Nº BROCAS	19
CALIDAD	HSSCo
CONTENIDO	Ø 1-10 x 0,50 mm
P.V.P. €	103,15

REFERENCIA	DC9511
Nº BROCAS	25
CALIDAD	HSSCo
CONTENIDO	Ø 1-13 x 0,50 mm
P.V.P. €	233,17

REFERENCIA	PC9510
Nº BROCAS	19
CALIDAD	HSSCo
CONTENIDO	Ø 1-10 x 0,50 mm
P.V.P. €	103,15

REFERENCIA	PC9511
Nº BROCAS	25
CALIDAD	HSSCo
CONTENIDO	Ø 1-13 x 0,50 mm
P.V.P. €	233,17

JUEGOS DE 13 BROCAS DIN 338

DIN 338

HSS

Plus

HSSCo 5%

TiN



(Brocas Ref. BC2)



(Brocas Ref. BC02)



(Brocas Ref. BC5)



(Brocas Ref. BC18)

REFERENCIA	D0009
Nº BROCAS	13
CALIDAD	HSS
CONTENIDO	Ø 1,5 - 6,5x0,5 (+3,2 & 4,8) mm
P.V.P. €	21,32

REFERENCIA	DP009
Nº BROCAS	13
CALIDAD	<i>Plus</i>
CONTENIDO	Ø 1,5 - 6,5x0,5 (+3,2 & 4,8) mm
P.V.P. €	25,06

REFERENCIA	DC009
Nº BROCAS	13
CALIDAD	HSSCo
CONTENIDO	Ø 1,5 - 6,5x0,5 (+3,2 & 4,8) mm
P.V.P. €	37,36

REFERENCIA	DT009
Nº BROCAS	13
CALIDAD	HSS+TiN
CONTENIDO	Ø 1,5 - 6,5x0,5 (+3,2 & 4,8) mm
P.V.P. €	33,33

(Brocas Ref. BC2)

(Brocas Ref. BC02)

(Brocas Ref. BC5)

(Brocas Ref. BC18)

REFERENCIA	D0008
Nº BROCAS	13
CALIDAD	HSS
CONTENIDO	Ø 1 - 7 x 0,50 mm
P.V.P. €	22,18

REFERENCIA	DP008
Nº BROCAS	13
CALIDAD	<i>Plus</i>
CONTENIDO	Ø 1 - 7 x 0,50 mm
P.V.P. €	25,11

REFERENCIA	DC008
Nº BROCAS	13
CALIDAD	HSSCo
CONTENIDO	Ø 1 - 7 x 0,50 mm
P.V.P. €	39,14

REFERENCIA	DT008
Nº BROCAS	13
CALIDAD	HSS+TiN
CONTENIDO	Ø 1 - 7 x 0,50 mm
P.V.P. €	36,45

(Brocas Ref. BC2)

(Brocas Ref. BC02)



(Brocas Ref. BC5)

(Brocas Ref. BC18)

BROCAS EN ESTUCHES METÁLICOS (Composiciones adicionales)
JUEGOS DE 12 BROCAS DIN 338

DIN 338	HSS	Plus	HSSCo 5%	TiN	HSSCo 8%
	(Brocas Ref. BC2)	(Brocas Ref. BC02)	(Brocas Ref. BC5)	(Brocas Ref. BC18)	(Brocas Ref. BC58)
REFERENCIA	D0006	DP006	DC006	DT006	DC806
Nº BROCAS	12	12	12	12	12
CALIDAD	HSS	Plus	HSSCo	HSS+TiN	HSSCo 8%
CONTENIDO	Ø 2-7x0,50 + 8 mm	Ø 2-7x0,50 + 8 mm	Ø 2-7x0,50 + 8 mm	Ø 2-7x0,50 + 8 mm	Ø 2-7x0,50 + 8 mm
P.V.P. €	40,71	42,13	58,67	53,32	77,31

BROCAS SERIE LARGA DIN 340

DIN 340	HSS	HSSCo 5%	TiN
			
	(Brocas Ref. BC4)	(Brocas Ref. BC47)	(Brocas Ref. BC40)
REFERENCIA	D0004	DC004	DT004
Nº BROCAS	19	17	19
CALIDAD	HSS	HSSCo	HSS+TiN
CONTENIDO	Ø 1-10 x 0,50 mm	Ø 2-10 x 0,50 mm	Ø 1-10 x 0,50 mm
P.V.P. €	95,33	202,94	146,84

BROCAS SERIE EXTRACORTA DIN 1897

DIN 1897	HSS	HSSCo 5%	HSSCo 5%	PMD	MD
	(Brocas Ref. BC3)	(Brocas Ref. BC31)	(Brocas Ref. BC33)	(Brocas Ref. BC77)	(Brocas Ref. BC43)
REFERENCIA	D3010	D3110	D3310	D7710	D4310
Nº BROCAS	19	19	19	17	17
CALIDAD	HSS	HSSCo	HSSCo "S"	Punta Metal Duro	Metal Duro Integral
CONTENIDO	Ø 1-10 x 0,50 mm	Ø 1-10 x 0,50 mm	Ø 1-10 x 0,50 mm	Ø 2-10 x 0,50 mm	Ø 2-10 x 0,50 mm
P.V.P. €	64,09	96,10	175,14	445,42	662,61



	(Brocas Ref. BC3)	(Brocas Ref. BC31)	(Brocas Ref. BC33)	(Brocas Ref. BC77)	(Brocas Ref. BC43)
REFERENCIA	D3011	D3111	D3311	D7711	D4311
Nº BROCAS	25	25	25	23	23
CALIDAD	HSS	HSSCo	HSSCo "S"	Punta Metal Duro	Metal Duro Integral
CONTENIDO	Ø 1-13 x 0,50 mm	Ø 1-13 x 0,50 mm	Ø 1-13 x 0,50 mm	Ø 2-13 x 0,50 mm	Ø 2-13 x 0,50 mm
P.V.P. €	122,90	201,92	316,97	745,72	1.408,86

BROCAS EN ESTUCHES METÁLICOS (Composiciones especiales)

BROCAS HSS PARA ALUMINIO

DIN 338

HSS **Al**



(Brocas Ref. BC16)

REFERENCIA	D16010	D16011
Nº BROCAS	19	25
CALIDAD	HSS	HSS
CONTENIDO	Ø 1-10 x 0,50 mm	Ø 1-13 x 0,50 mm
P.V.P. €	87,35	191,64

BROCAS HSSCO CON GEOMETRÍA TIPO "S"

DIN 338

HSSCo 5% **INOX**



(Brocas Ref. BC55)

REFERENCIA	D55010	D55011
Nº BROCAS	18	24
CALIDAD	HSSCo	HSSCo
CONTENIDO	Ø 1,50-10 x 0,50 mm	Ø 1,50-13 x 0,50 mm
P.V.P. €	178,48	406,41

BROCAS CON PUNTA DE METAL DURO PARA ACEROS TRATADOS, FUNDICIÓN, ETC.

DIN 338

PMD

FUNDICIÓN



(Brocas Ref. BC7)

REFERENCIA	DPMD010	DPMD011
Nº BROCAS	17	23
CALIDAD	Punta Metal Duro	Punta Metal Duro
CONTENIDO	Ø 2-10 x 0,50 mm	Ø 2-13 x 0,50 mm
P.V.P. €	359,03	617,81

BROCAS DE METAL DURO INTEGRAL PARA MATERIALES MUY DUROS

DIN 338

MD

ALTA PRODUCCIÓN



(Brocas Ref. BC42)

REFERENCIA	D42010	D42011
Nº BROCAS	17	23
CALIDAD	Metal Duro Integral	Metal Duro Integral
CONTENIDO	Ø 2-10 x 0,50 mm	Ø 2-13 x 0,50 mm
P.V.P. €	982,99	2.225,59

JUEGOS DE BROCAS HSSCO 8%

DIN 338

HSSCo 8%



(Brocas Ref. BC58)

REFERENCIA	ADC81	ADC82	D89380
Nº BROCAS	37	49	19
CALIDAD	HSSCo 8%	HSSCo 8%	HSSCo 8%
CONTENIDO	Ø 1-10 x 0,25 mm	Ø 1-13 x 0,25 mm	Ø 1-10 x 0,50 mm
P.V.P. €	307,40	721,31	126,99

REFERENCIA	DC807	DC817	DC835
Nº BROCAS	10	23	29
CALIDAD	HSSCo 8%	HSSCo 8%	HSSCo 8%
CONTENIDO	Ø 1-10 x 1 mm	Ø 1-10 x 0,50 mm + previos*	Ø 1-13 x 0,50 mm + previos*
P.V.P. €	97,16	197,95	389,24

* Previos: de M3 a M12 (Ø3,30 - Ø4,20 - Ø6,80 - Ø10,20)

BROCAS EN ESTUCHES METÁLICOS (Composiciones especiales)
BROCAS ESPECIALES PARA ACERO INOXIDABLE
DIN
338
HSSCo
5%
TiAIN
INOX
Plus

(Brocas Ref. BC50)

REFERENCIA	D50010	D50011
Nº BROCAS	19	25
CALIDAD	HSSCo	HSSCo
CONTENIDO	Ø 1-10 x 0,50 mm	Ø 1-13 x 0,50 mm
P.V.P. €	310,87	534,61

BROCAS CON CORTE IZQUIERDA
DIN
338
HSS

(Brocas Ref. BC15)

REFERENCIA	D0010I	D0011I	DR9312I
Nº BROCAS	19	25	10
CALIDAD	HSS	HSS	HSS
CONTENIDO	Ø 1-10 x 0,50 mm	Ø 1-13 x 0,50 mm	Ø 1-10 x 1 mm
P.V.P. €	162,27	342,02	80,66

ESTUCHES METÁLICOS
ESTUCHES VACÍOS

REFERENCIA	D0010V	D0011V	AD001V
Nº BROCAS	19	25	37
CONTENIDO	Ø 1-10 x 0,50 mm	Ø 1-13 x 0,50 mm	Ø 1-10 x 0,25 mm
P.V.P. €	17,10	23,86	62,67



REFERENCIA	AD002V	D0014V	D0015V	D0022V	D0006V
Nº BROCAS	49	50	41	81	12
CONTENIDO	Ø 1-13 x 0,25 mm	Ø 1-5,9 x 0,10 mm	Ø 6-10 x 0,10 mm	Ø 2-10 x 0,10 mm	Ø 2-7x0,50 + 8 mm
P.V.P. €	72,79	55,51	110,91	212,72	23,21

REFERENCIA	D0007V	D0017V	D0035V	DE10V (Extra corta)	DE11V (Extra corta)
Nº BROCAS	10	23	29	19	25
CONTENIDO	Ø 1-10 x 1 mm	Ø 1-10 x 0,50 mm + previos*	Ø 1-13 x 0,50 mm + previos*	Ø 1-10 x 0,50 mm	Ø 1-13 x 0,50 mm
P.V.P. €	39,82	46,18	65,31	40,39	49,35

* Previos: de M3 a M12 (Ø3,30 - Ø4,20 - Ø6,80 - Ø10,20)

JUEGOS DE BROCAS EN ESTUCHES DE PLÁSTICO RECTIFICADAS MICROBROCAS, AEROMODELISMO Y MARQUETERÍA
DIN
338

Ref. DR9120

REFERENCIA	DR9120	DC9120	DR9102
Nº BROCAS	10	10	15
CALIDAD	HSS	HSSCo5%	HSS
CONTENIDO	Ø 1-1,90 x 0,10 mm	Ø 1-1,90 x 0,10 mm	Ø 0,30 - 0,35 - 0,40 - 0,45 - 0,50 - 0,55 - 0,60 0,65 - 0,70 - 0,75 - 0,80 - 0,85 - 0,90 - 0,95 - 1
P.V.P. €	21,54	32,48	43,20

BROCAS EN ESTUCHES DE PLÁSTICO

Brocas Metal

Rosa Gris

DIN 338 HSS

(Brocas Ref. BC2)



REFERENCIA	DR9314	DR9312	DR9313	DR9311
Nº BROCAS	6	10	13	19
CALIDAD	HSS	HSS	HSS	HSS
CONTENIDO	Ø 2 - 3 - 4 - 5 - 6 - 8 mm	Ø 1-10 x 1 mm	Ø 2-8 x 0,50 mm	Ø 1-10 x 0,50 mm
P.V.P. €	15,19	32,35	32,10	56,52

Plus

(Brocas Ref. BC02)



REFERENCIA	DP9314	DP9312	DP9313	DP9311
Nº BROCAS	6	10	13	19
CALIDAD	Plus	Plus	Plus	Plus
CONTENIDO	Ø 2 - 3 - 4 - 5 - 6 - 8 mm	Ø 1-10 x 1 mm	Ø 2-8 x 0,50 mm	Ø 1-10 x 0,50 mm
P.V.P. €	16,01	35,03	34,23	61,78

HSSCo 5%

(Brocas Ref. BC5)



REFERENCIA	DC9314	DC9312	DC9313	DC9311
Nº BROCAS	6	10	13	19
CALIDAD	HSSCo	HSSCo	HSSCo	HSSCo
CONTENIDO	Ø 2 - 3 - 4 - 5 - 6 - 8 mm	Ø 1-10 x 1 mm	Ø 2-8 x 0,50 mm	Ø 1-10 x 0,50 mm
P.V.P. €	24,15	51,80	52,17	92,58

HSS TiN

(Brocas Ref. BC18)



REFERENCIA	DT9314	DT9312	DT9313	DT9311
Nº BROCAS	6	10	13	19
CALIDAD	HSS+TiN	HSS+TiN	HSS+TiN	HSS+TiN
CONTENIDO	Ø 2 - 3 - 4 - 5 - 6 - 8 mm	Ø 1-10 x 1 mm	Ø 2-8 x 0,50 mm	Ø 1-10 x 0,50 mm
P.V.P. €	17,59	37,44	37,15	65,40

BROCAS EN ESTUCHES PLÁSTICO (Composiciones especiales)

Brocas Metal

Gris
Rosa
HSS **BRILLANTE**

(Brocas Ref. BC82)



REFERENCIA	D829314	D829312	D829313	D829311
Nº BROCAS	6	10	13	19
CALIDAD	HSS	HSS	HSS	HSS
CONTENIDO	Ø 2 - 3 - 4 - 5 - 6 - 8 mm	Ø 1 - 10 x 1 mm	Ø 2 - 8 x 0,50 mm	Ø 1 - 10 x 0,50 mm
P.V.P. €	15,19	32,35	32,10	56,52

HSSCo
8%

(Brocas Ref. BC58)



REFERENCIA	D89314	D89312	D89313	D89311
Nº BROCAS	6	10	13	19
CALIDAD	HSSCo 8%	HSSCo 8%	HSSCo 8%	HSSCo 8%
CONTENIDO	Ø 2 - 3 - 4 - 5 - 6 - 8 mm	Ø 1 - 10 x 1 mm	Ø 2 - 8 x 0,50 mm	Ø 1 - 10 x 0,50 mm
P.V.P. €	32,56	69,64	71,37	125,20

HSSCo
5%

(Brocas Ref. BC95)



REFERENCIA	DC959314
Nº BROCAS	6
CALIDAD	HSSCo 5%
CONTENIDO	Ø 2 - 3 - 4 - 5 - 6 - 8 mm
P.V.P. €	25,14

BOTES CLASIFICADORES DE PLÁSTICO DE 19 PIEZAS
DIN
338
HSS

(Brocas Ref. BC2)

Plus

(Brocas Ref. BC02)

HSSCo
5%

(Brocas Ref. BC5)

TiN

(Brocas Ref. BC18)

REFERENCIA	DR9380	DP9380	DC9380	DT9380
Nº BROCAS	19	19	19	19
CALIDAD	HSS	<i>Plus</i>	HSSCo	HSS + TiN
CONTENIDO	Ø 1 - 10 x 0,50 mm	Ø 1 - 10 x 0,50 mm	Ø 1 - 10 x 0,50 mm	Ø 1 - 10 x 0,50 mm
P.V.P. €	56,00	62,77	93,37	82,98

ESTUCHES DE PLÁSTICO MIXTOS: HSS, WIDIA Y MADERA

SERIE STANDARD

HSS (Ref. BC2) PMD (Ref. BW1) CV (Ref. BM)							
	REFERENCIA	EC9330	EC9331	EC9332	EC9382		
	Nº BROCAS	8	9	9	18		
CALIDAD	 	  	  	  			
CONTENIDO	Ø 4 - 5 - 6 - 8 mm x 2	Ø 4 - 6 - 8 mm x 3	Ø 5 - 6 - 8 mm x 3	Ø 3 - 4 - 5 - 6 - 8 - 10 mm x 3			
P.V.P. €	19,51	20,79	21,20	40,12			

SERIE PROFESIONAL

HSSCo 5% (Ref. BC5) PMD (Ref. BW6) HSS (Ref. BMPR)							
	REFERENCIA	M9330	M9331	M9332	M9382		
	Nº BROCAS	8	9	9	18		
CALIDAD	 	  	  	  			
CONTENIDO	Ø 4 - 5 - 6 - 8 mm x 2	Ø 4 - 6 - 8 mm x 3	Ø 5 - 6 - 8 mm x 3	Ø 3 - 4 - 5 - 6 - 8 - 10 mm x 3			
P.V.P. €	33,71	33,10	33,77	66,02			

SERIE EXTRA PROFESIONAL

HSSCo 5% (Ref. BC5) PMD (Ref. BW15) HSS (Ref. BMPR)							
	REFERENCIA	P9330	P9331	P9332	P9382		
	Nº BROCAS	8	9	9	18		
CALIDAD	 	  	  	  			
CONTENIDO	Ø 4 - 5 - 6 - 8 mm x 2	Ø 4 - 6 - 8 mm x 3	Ø 5 - 6 - 8 mm x 3	Ø 3 - 4 - 5 - 6 - 8 - 10 mm x 3			
P.V.P. €	50,03	45,66	46,50	92,93			

ARMARIOS EXPOSITORES PARA BROCAS CILÍNDRICAS DIN 338

Brocas Metal

Grís

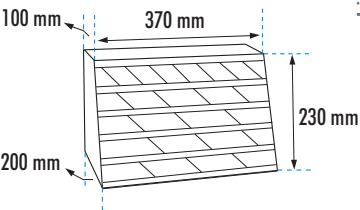

Ref. BC2
DIN 338
HSS
 **118°**
 **30° "N"**
 **OX**
 **70 Kg/mm²**

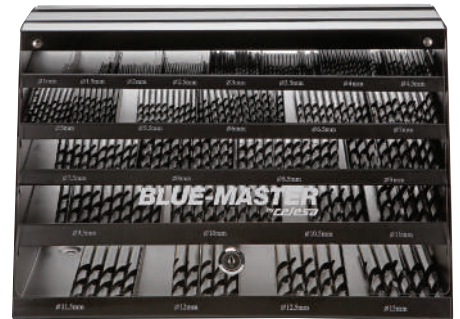

HSS

CONTENIDO 400 BROCAS

Brocas BC2

1,00 10	1,50 10	2,00 20	2,50 20	3,00 50	3,50 30	4,00 40	4,50 20	5,00 40	5,50 10	6,00 30	6,50 10	7,00 10
7,50 10	8,00 20	8,50 10	9,00 10	9,50 10	10,00 10	10,50 5	11,00 5	11,50 5	12,00 5	12,50 5	13,00 5	

EXPBROCASBC2

1.073,00 €

Ref. BC02
DIN 338
HSS-G Plus
 **118°**
 **30° "N"**
 **OX**
 **70 Kg/mm²**



HSS-G Plus

CONTENIDO 316 BROCAS

Brocas BC02

1,00 10	1,50 10	2,00 20	2,50 10	3,00 20	3,50 10	4,00 30	4,50 10	5,00 30	5,50 10	6,00 30	6,50 10	7,00 10
7,50 10	8,00 20	8,50 10	9,00 10	9,50 10	10,00 10	10,50 6	11,00 6	11,50 6	12,00 6	12,50 6	13,00 6	

EXPBROCASBC02

1.145,26 €



ARMARIOS EXPOSITORES PARA BROCAS CILÍNDRICAS DIN 338



Ref. BC5

DIN 338

HSSCo 5%



135°



30° "N"



DORADO



120 Kg/mm²



HSSCo 5%

CONTENIDO 220 BROCAS

Brocas BC5

1,00 10	1,50 10	2,00 10	2,50 10	3,00 10	3,50 10	4,00 10	4,50 10	5,00 10	5,50 10	6,00 10	6,50 10	7,00 10
7,50 10	8,00 10	8,50 10	9,00 10	9,50 10	10,00 10	10,50 5	11,00 5	11,50 5	12,00 5	12,50 5	13,00 5	

EXPBROCASBC5

1.477,05 €

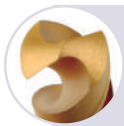

Ref. BC18

DIN 338

HSS



118°



30° "N"



TiN



PRODUCCIÓN

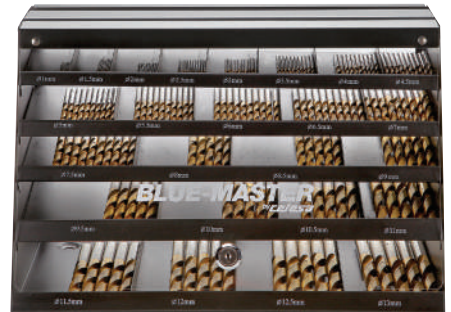

HSS



TiN

CONTENIDO 200 BROCAS

Brocas BC18

1,00 10	1,50 10	2,00 10	2,50 10	3,00 10	3,50 10	4,00 10	4,50 10	5,00 10	5,50 10	6,00 10	6,50 10	7,00 10
7,50 10	8,00 10	8,50 5	9,00 5	9,50 5	10,00 5	10,50 5	11,00 5	11,50 5	12,00 5	12,50 5	13,00 5	

EXPBROCASBC18

1.099,85 €



Ref. BC95

DIN 338

HSSCo 5%



130°



Ø ≥ 3

OX DORADO

INOX



HSSCo 5%

CONTENIDO 176 BROCAS

Brocas BC95

1,00 10	1,50 10	2,00 10	2,50 10	3,00 10	3,50 10	4,00 10	4,50 10	5,00 10	5,50 10	6,00 10	6,50 10	7,00 10
7,50 10	8,00 10	8,50 5	9,00 5	9,50 5	10,00 5	10,50 1	11,00 1	11,50 1	12,00 1	12,50 1	13,00 1	

EXPBROCASBC95

981,16 €

MALETAS METÁLICAS DE BROCAS RECTIFICADAS

DIN
338

125 BROCAS Ø 1-10 mm x 0,50

Ø	1	1,50	2	2,50	3	3,50	4	4,50
Cant.	10	5	10	5	10	5	10	5
	5	5,50	6	6,50	7	7,50	8	8,50
	10	5	10	5	5	5	5	5
	9	9,50	10	= 125 BROCAS				
	5	5	5					



REFERENCIA	BC2880	BC02880	BC5880	BC18880	M0880V
Nº BROCAS	125	125	125	125	250
CALIDAD	HSS	Plus	HSSCo 5%	HSS TiN	
CONTENIDO	Ø 1-10 x 0,50 S/DETALLE	Ø 1-10 x 0,50 S/DETALLE	Ø 1-10 x 0,50 S/DETALLE	Ø 1-10 x 0,50 S/DETALLE	ESTUCHE VACÍO
P.V.P. €	337,31	378,11	558,36	482,72	136,32

DIN
338

155 BROCAS Ø 1-13 mm x 0,50

Ø	1	1,50	2	2,50	3	3,50	4	4,50	5
Cant.	10	5	10	5	10	5	10	5	10
	5,50	6	6,50	7	7,50	8	8,50	9	9,50
	5	10	5	5	5	5	5	5	5
	10	10,50	11	11,50	12	12,50	13	= 155 BROCAS	
	5	5	5	5	5	5	5		



REFERENCIA	BC2881	BC02881	BC5881	BC18881	M0881V
Nº BROCAS	155	155	155	155	290
CALIDAD	HSS	Plus	HSSCo 5%	HSS TiN	
CONTENIDO	Ø 1-13 x 0,50 S/DETALLE	Ø 1-13 x 0,50 S/DETALLE	Ø 1-13 x 0,50 S/DETALLE	Ø 1-13 x 0,50 S/DETALLE	ESTUCHE VACÍO
P.V.P. €	677,52	753,04	1.202,31	983,45	315,68

MALETINES METÁLICOS DE BROCAS CÓNICAS DIN 345

DIN
345

HSS



(Brocas Ref. BC11)

REFERENCIA	MBC11-1	MBC11-2
Nº BROCAS	10	10
CALIDAD	HSS	HSS
CONTENIDO	Ø 14 - 15 - 16 - 17 - 18 - 19 - 20 - 21 - 22 - 23	Ø 14 - 16 - 18 - 20 - 22 - 24 - 25 - 26 - 28 - 30
P.V.P. €	618,45	862,80

TABLA DE CONSULTA DE VELOCIDADES Y AVANCES PARA BROCAS

			DIÁMETRO Ø (mm)											
			2	3	5	7	10	12	15	18	20	22	25	30
ACERO BLANDO 70 kg/mm ² BC2	V/C 25 m/min	RPM	3979	2653	1592	1137	796	663	531	442	398	362	318	265
		mm / vuelta	0,04	0,06	0,08	0,15	0,20	0,26	0,30	0,33	0,34	0,35	0,35	0,39
		S (mm / min)	159	159	127	171	159	172	159	146	135	127	111	103
ACERO TRATADO 120 kg/mm ² BC5	V/C 13 m/min	RPM	2069	1379	828	591	414	345	276	230	207	188	166	138
		mm / vuelta	0,03	0,045	0,06	0,10	0,15	0,18	0,20	0,22	0,23	0,25	0,25	0,28
		S (mm / min)	62	62	50	59	62	60	55	51	48	47	41	39
INOXIDABLE BC50	V/C 11 m/min	RPM	1751	1167	700	500	350	292	233	195	175	159	140	117
		mm / vuelta	0,02	0,05	0,08	0,14	0,19	0,23	0,25	0,27	0,28	0,30	0,31	0,33
		S (mm / min)	35	58	56	70	67	67	58	53	49	48	43	39
ALUMINIO BC16	V/C 50 m/min	RPM	7958	5305	3183	2274	1592	1326	1061	884	796	723	637	531
		mm / vuelta	0,03	0,06	0,08	0,16	0,20	0,23	0,25	0,28	0,29	0,30	0,30	0,36
		S (mm / min)	239	318	255	364	318	305	265	248	231	217	191	191
TITANIO BC42	V/C 18 m/min	RPM	5570	3714	2228	1592	1114	928	743	619	557	506	446	371
		mm / vuelta	0,02	0,03	0,03	0,05	0,08	0,08	0,12	0,15				
		S (mm / min)	111	111	67	80	84	74	89	93				
FUNDICIÓN BC7	V/C 25 m/min	RPM	3979	2653	1592	1137	796	663	531	442	398	362	318	265
		mm / vuelta	0,05	0,08	0,10	0,20	0,27	0,31	0,37	0,41	0,42	0,42	0,42	0,45
		S (mm / min)	199	199	159	227	215	206	196	181	167	152	134	119
LATÓN BC66	V/C 50 m/min	RPM	7958	5305	3183	2274	1592	1326	1061	884	796	723	637	531
		mm / vuelta	0,04	0,07	0,08	0,17	0,21	0,25	0,28	0,28	0,30	0,30	0,33	0,40
		S (mm / min)	318	345	239	387	334	332	297	248	239	217	210	212
PLÁSTICO FIBRA DE CARBONO BC7	V/C 12 m/min	RPM	1911	1274	764	546	382	318	255	212	191	174	153	127
		mm / vuelta	0,02	0,03	0,03	0,05	0,08	0,08	0,12	0,15				
		S (mm / min)	38	38	23	27	29	25	31	32				
ALEACIONES NI BC42	V/C 30 m/min	RPM	4775	3183	1910	1364	955	796	637	531	477	434	382	318
		mm / vuelta	0,015	0,02	0,02	0,03	0,04	0,06	0,07	0,08	0,11	0,12	0,15	
		S (mm / min)	72	64	42	34	38	48	45	42	53	52	57	
CIRCUITOS IMPRESOS BC79	25	RPM	3979	-	-	-	-	-	-	-	-	-	-	

Brocas Metal

OBSERVACIONES:

- Conocidos el diámetro de la broca y el material a taladrar, la velocidad y el avance se identifican rápidamente.

Ejemplo;

Material: Aluminio

Ø de broca: 7 mm

RPM = 2274

S = 364 mm/min

- Tras realizar los primeros orificios es necesario ajustar tanto la velocidad como el avance.

INFORMACIÓN TÉCNICA SOBRE DIMENSIONES DE CONOS MORSE DIN 228D



CONO MORSE	Adelgazamiento	Ø 2	a	b h13	d ₁	d ₂ Ø mayor =	d ₆ Ø menor =	d ₇ Dimen. máx.	l ₃ -1	l ₄ Dimen. máx.	l ₅ Dimen. máx.	r ₁	r ₂
0	1:19,212=0,05205	1°29 27"	3,0	3,9	9,045	9,2	6,1	6,0	56,5	59,5	10,5	4	1,0
1	1:20,047=0,04988	1°25 43"	3,5	5,2	12,065	12,2	9,0	8,7	62,0	65,5	13,5	5	1,2
2	1:20,020=0,04995	1°25 50"	5,0	6,3	17,780	18,0	14,0	13,5	75,0	80,0	16,0	6	1,6
3	1:19,922=0,05020	1°26 16"	5,0	7,0	23,825	24,1	19,1	18,5	94,0	99,0	20,0	7	2,0
4	1:19,254=0,05194	1°29 15"	6,5	11,9	31,267	31,6	25,2	24,5	117,5	124,0	24,0	8	2,5
5	1:19,002=0,05263	1°30 26"	6,5	15,9	44,399	44,7	36,5	35,7	149,5	156,0	29,0	10	3,0
6	1:19,180=0,05214	1°29 36"	8,0	19,0	63,348	63,8	52,4	51,0	210,0	218,0	40,0	10	4,0

▶ NUEVOS ARMARIOS DE BROCAS PARA METAL

El armario perfecto para exponer sus brocas de alta rotación.

Tapas de cierre delantera y trasera transparentes, permite una visualización atractiva de las brocas disponibles, con más orden y mejor presentación.

Tapa trasera abatible que permite rellenar con facilidad los huecos desde el mostrador.

Cierre con llave de seguridad por delante y por detrás, facilita el acceso durante el despacho de material.

Imágenes descriptivas del contenido en los paneles laterales, atrae la atención del público.



Ref. EXPBROCASC2



Ref. EXPBROCASC5

▶ AMPLIA GAMA DE ESTUCHES PARA BROCAS

▶ Plástico Azul

Rígido, Robusto y Ligero

Ventana transparente

Plástico reforzado con goma antichoque



Ref. P6010



Ref. PT6011

Ref. PP6010



Ref. PC011

▶ Plástico Negro

Ligero, manejable

Plástico reforzado con goma

Alta resistencia y durabilidad



▶ Metal Clásico

Caja metálica alta resistencia



Ref. DC010



Ref. DP011